



HIGH PRECISION

# TOOL-A-THON®



**Volume 24.1** Valid Jan. 1<sup>st</sup> - Apr. 30<sup>th</sup>  
[www.fowlerprecision.com](http://www.fowlerprecision.com)

# NEW Fulcrum Revolutionary Manual CMM



Fowler FUSION  
Metrology Software



## Features

- Small footprint allowing measurements right next to your machine
- Intuitive software, allows quick and easy measurement
- Minimal setup
- Programmable magnetic soft buttons allow you to quickly change between software features without using a mouse
- Magnetic fixture templates allow you to quickly fix your part
- Volumetric accuracy of 0.0002"/0.005mm
- Uses a single USB cable to connect and requires no air

Order No. 54-960-400-0



## Mark 1 CMM

### Features:

- Shop floor hardened for use at the machine center
- Easy to use FUSION Software
- Robust enough to use around the clock
- 5 temp. sensors allow for use in uncontrolled environments

Fowler FUSION  
Metrology Software

Order No.	Description
MK1-EXT-370	(XY) 370mm x (Z) 270mm
MK1-EXT-520	(XY) 520mm x (Z) 300mm

## zCAT Portable CMM

### Features:

- Compact for use at the machine center
- Easy to use FUSION Software
- Completely portable, only 30 lbs.
- High accuracy
- Ethernet communication (Bluetooth optional)



Order No. 54-950-001-0

## Horizontal Setting and Calibration

*Setting of measuring equipment with variable dimensions.*

### THV Horizontal



Order No. 54-198-558-0

### Features:

- For the calibration of rings, plugs and multiple gages up to 4"
- Small, portable, versatile and accurate
- Ultra precise
- Meets ISO 9000 requirements

### HS6

### Features:

- For setting equipment with variable dimensions quickly and accurately
- Available in sizes up to 120"
- Large selection of accessories to handle any job



Order No. 54-196-900-5

## NEW Rapid Measuring Systems

### Features:

- Simultaneous measuring up to 100 parts
- Simple place and press measurement finish in 3 seconds
- No more operator errors
- Powerful yet easy to use measuring software
- Up to 12" x 8" field of view
- High resolution: 0.00004"/0.0001mm



Measures multiple parts simultaneously



One touch measuring



- ✓ Place your parts
- ✓ Press the button
- ✓ See the results in seconds

Model No.	Field Of View
54-830-310-0	100mm x 200mm
54-830-320-0	200mm x 200mm
54-830-830-0	300mm x 200mm

Order No. 54-830-830-0

**Call for more information, 1-800-788-2353!**

## Venture 3030 XT Multi-Sensor Vision System



### Features:

- 11.8"/300mm x 11.8"/300mm x 7.8"/200mm XYZ stage
- Teach and repeat programming with Fowler FUSION
- 6.5:1 zoom optics (with optional CNC control)
- High resolution 0.5µm scales for increased accuracy

**Fowler FUSION**  
Metrology Software

Order No. 54-242-000-0

# Discovery Kit

Discover the benefits of the wireless connectivity!



24.1

# FREE

with the purchase of ANY  
**NEW Sylvac SCAN**  
(excluding trade-ins)

**Includes:**

- 1 caliper, 1 digital indicator, 1 micrometer and 1 test indicator. ALL with Bluetooth® Technology
- Sylcom PRO Software (Smart dongle included)
- Accessory for battery change



over \$5,000 value

**Order No. 54-167-050-0**

## SCAN S25T

*Fast, Accurate, Reliable & Repeatable!*

**Features:**

- Ideal for small cylindrical parts
- Measuring range: 1.02"/26mm Diameter, 7.87"/200mm Length
- High resolution and high accuracy
- One-click rapid measuring
- 30° tilting optics for complete thread measurements

**Order No. 54-902-025-5**



## SCAN F60T

*For Larger Parts!*

**Features:**

- Complete 2D part scan in less than 3 seconds
- Measuring range: 2.3"/60mm diameter, 12"/300mm length
- Reduce inspection time & scrap, Increase productivity
- High resolution and high accuracy
- One-click rapid measuring
- 30° tilting optics for complete thread measurements

**Order No. 54-902-406-5**

## SCAN S145L

*Our Largest Machine!*

**Features:**

- Full part measurement in just a few seconds
- Measuring range: 5.7"/145mm diameter, 50.3"/1280mm length
- Reduce inspection time & scrap, Increase productivity
- High resolution and high accuracy
- One-click rapid measuring

**Order No. 54-902-145-5**



Systems



## Fowler Trimos V Series Electronic Height Gages

The Fowler Trimos V series vertical measuring instruments have been developed for the most difficult shop floor environments. Manufactured in Switzerland, they guarantee precise and repeatable measurements with superior ease of use.

### Features:

- Electronically adjustable measuring force 0.75/1.5 (N)
- Lithium-ion rechargeable batteries last up to 40 hours
- Bluetooth transmitter available
- **V7:** Repeatability (2s): 0.00002"/0.0005mm (Ø 0.00004"/0.001mm)

### All models Include:

- Charging unit
- Measuring probe with ruby ball Ø4mm
- Probe holder elbow Ø 8mm
- Setting gage
- User's manual and test certificate



54-192-340-0



54-199-570-0



54-199-970-0



54-191-440-0



54-199-770-0

*Measures ID/OD, centerlines, heights, widths, depths, min/max/delta, slots, grooves and more!*

# V-Series Electronic Height Gages Comparison Chart

24.1

	V9	V8	V7	V6	V5	V4	V3
<b>Accuracy</b>							
1.2 + L(mm)/1000 μm	✓	✓					
2 + L(mm)/400 μm			✓	✓			
2.5 + L(mm)/300 μm					✓		
4.5 - 6 μm						✓	
7 - 8 μm							✓
<b>Range</b>							
400/700mm	✓	✓	✓	✓	✓	✓	✓
1100mm	✓	✓	✓	✓	✓		
<b>Smart Reverse for Ø</b>	✓	✓	✓	✓	✓	✓	✓
<b>Air Cushion</b>	✓	✓	✓	✓	✓	✓	✓
<b>Wireless Option</b>	✓	✓	✓	✓	✓	✓	
<b>Manual/Motorized</b>	✓		✓	✓	✓		
<b>Manual ONLY</b>		✓				✓	✓
<b>Fine Adjustment</b>		✓					
<b>Color Display</b>	✓		✓				
<b>2D Measuring</b>	✓		✓				

**Certify Any Height Gage  
Below For Only \$199.00**

Valid only for Tool-A-Thon 24.1

Height Gages

Order No.	Range	List Price	Sale Price
V3			
54-192-340-0	16"/407mm	\$5,419.97	<b>\$5,149.00</b>
54-192-370-0	28"/711mm	\$5,511.60	<b>\$5,237.00</b>
V4			
54-191-440-0	16"/407mm	\$6,584.83	<b>\$6,256.00</b>
54-191-470-0	28"/711mm	\$8,305.31	<b>\$7,891.00</b>
V5			
54-199-540-0	16"/407mm	\$7,257.34	<b>\$6,895.00</b>
54-199-570-0	28"/711mm	\$8,600.23	<b>\$8,171.00</b>
54-199-590-0	43.7"/1110mm	\$13,583.85	<b>\$12,905.00</b>
V6			
54-199-640-0	16"/407mm	\$9,014.34	<b>\$8,564.00</b>
54-199-670-0	28"/711mm	\$10,458.85	<b>\$9,936.00</b>
54-199-690-0	43.7"/1110mm	\$15,163.41	<b>\$14,406.00</b>
V7			
54-199-740-0	16"/407mm	\$11,963.78	<b>\$11,366.00</b>
54-199-770-0	28"/711mm	\$12,781.27	<b>\$12,143.00</b>
54-199-790-0	44"/1100mm	\$18,311.10	<b>\$17,396.00</b>
V8 - Fine Adjustment			
54-199-840-0	16"/407mm	\$13,157.00	<b>\$12,500.00</b>
54-199-870-0	28"/710mm	\$14,508.73	<b>\$13,784.00</b>
54-199-890-0	43"/1109mm	\$21,389.93	<b>\$20,321.00</b>
V9			
54-199-940-0	16"/407mm	\$13,871.20	<b>\$13,178.00</b>
54-199-970-0	28"/710mm	\$14,254.65	<b>\$13,542.00</b>
54-199-990-0	43"/1109mm	\$21,462.33	<b>\$20,390.00</b>
Probe Sets			
54-199-105-0	4mm Probe Set, 21 piece	\$1,923.23	<b>\$1,828.00</b>
54-199-106-0	8mm Probe Set, 16 piece	\$1,556.00	<b>\$1,479.00</b>
54-199-107-0	8mm Basic Probe Set, 7 piece	\$509.53	<b>\$485.00</b>
Accessories			
45-300-002-0	ISO Certification	\$379.00	<b>\$199.00</b>
54-199-400-0	12"/300mm Holder - for 8mm probes	\$1,167.27	<b>\$1,109.00</b>
54-199-022-BT	Bluetooth transmitter (Not available for V3 models)	\$675.78	<b>\$642.00</b>
54-777-120-0	Vmox software - for connecting multiple units to one PC	\$538.54	<b>\$485.00</b>

Prices & Specifications are subject to change without notice.

Fowler

# Fowler Sylvac Hi\_Cal V2 Electronic Height Gages

For your finer, more delicate parts.

**FREE 1mm Ball Probe**  
with 6"/150mm and 12"/300mm Hi\_Cal Purchase!

 **sylvac**

 **SWISS MADE** 



54-931-150-BT



54-931-300-BT



54-931-450-BT

## Features:

- **Bluetooth for quick, easy recorded measurements**
- Extra low measuring force, from 0.2N
- Measure internal and external diameters, centerlines, heights, widths, depths and MIN/MAX/TIR capability
- Excellent repeatability thanks to the motorized carriage
- High reliability
- Bluetooth, USB and RS232 data outputs
- Battery life: 40 hours rechargeable during operation
- Touch sensitive probe speed for easy operation
- Base with small footprint
- Includes: protective cover, charging set, ruby ball probe Ø3mm, setting gage and calibration certificate

**NOW**

**available with ISO Cert**

Contact the Fowler Sales Department 1-800-788-2353

## Full Probe Set



54-930-215-0

## FREE Basic Probe Set

with 54-931-450-BT Hi\_Cal Purchase  
\$951.03 Value!



54-930-217-0

Order No.	Range	Accuracy	List Price	Sale Price
54-931-150-BT	6"/150mm	0.00013"/0.0034mm	\$6,080.26	<b>\$5,473.00</b>
54-931-150-BT-C	6"/150mm <i>with ISO/A2LA Certification</i>			<b>\$5,724.00</b>
54-931-300-BT	12"/300mm	0.00016"/0.0042mm	\$6,636.83	<b>\$5,974.00</b>
54-931-300-BT-C	12"/300mm <i>with ISO/A2LA Certification</i>			<b>\$6,315.00</b>
54-931-450-BT	17.5"/450mm	0.00020"/0.005mm	\$7,157.13	<b>\$6,442.00</b>
54-931-450-BT-C	17.5"/450mm <i>with ISO/A2LA Certification</i>			<b>\$6,783.00</b>
Accessories				
54-930-215-0	Full Probe Set		\$1,771.05	<b>\$1,594.00</b>
54-930-217-0	Basic Probe Set		\$951.03	<b>\$856.00</b>



**Z-HEIGHT****Electronic Height Gages***With handwheel and fine adjust.***Features:**

- Base design has a more comfortable grip and is finely ground and lapped for smooth movement on surface plates
- Fine adjust feature allows precise adjustment to required settings
- Preset feature allows setting pre-determined or reference measurements
- Indicator holding bar included
- Resolution 0.0005"/0.01mm
- Large, high contrast LCD display
- Coarse adjustment hand wheel
- Carriage locking lever
- Carbide tipped scriber



54-175-024-0

**Calibration certificates available for all sizes.**

Order No.	Range	Accuracy	List Price	Sale Price
54-175-018-0	18"/450mm	± 0.002"/0.05mm	\$696.17	<b>\$627.00</b>
54-175-024-0	24"/600mm	± 0.002"/0.05mm	\$896.81	<b>\$808.00</b>

**Single Beam  
Electronic Height Gages****Features:**

- Measuring range: 40"/1000mm
- Accuracy: ± 0.0025"
- Large base is lapped for easy movement
- Resolution: 0.0005"/.01mm
- Large easy to read LCD
- Presetable display
- Carbide tipped scriber

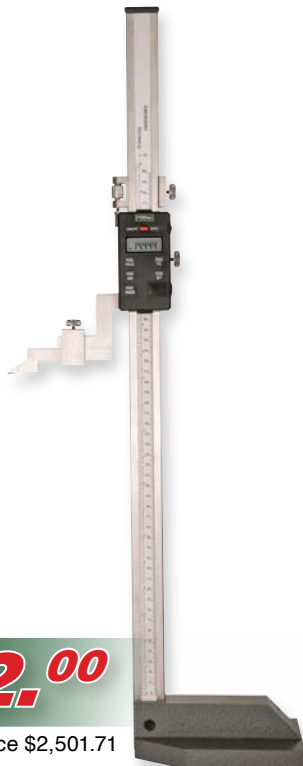
**Calibration certificate available.****Order No. 54-106-040-0****Sale \$2,252.00**

List Price \$2,501.71

# Fowler Bowers **BLUETOOTH**



## XTH3 Bluetooth Holematic Pistol Grips

### Features:

- Coolant proof, dust proof - IP67
- Resolution: 0.00005"/0.001mm
- Bluetooth connectivity to your phone or tablet
- Self centering 3 point heads above 0.250"
- Tungsten carbide measuring faces on all 3-point heads from 0.5"/12.5mm and up
- Sizes over 0.500"/12.5mm feature blind bore capability
- Includes UKAS certificates for all pistol grip, heads and rings



54-567-100-BT

For special application heads, contact the Fowler Technical Department 1-800-788-2353

Order No.	Range	Includes	List Price	Save Price
<b>Pistol Grip Individual Sets</b>				
54-567-720-BT	0.750" - 1"/20 - 25mm	1 head, 1 handle, 1 ring	\$2,635.52	<b>\$2,372.00</b>
54-567-725-BT	1" - 1.375"/25 - 35mm	1 head, 1 handle, 1 ring	\$2,995.57	<b>\$2,697.00</b>
54-567-735-BT	1.375" - 2"/35 - 50mm	1 head, 1 handle, 1 ring	\$3,075.38	<b>\$2,768.00</b>
<b>Pistol Grip Complete Sets</b>				
54-567-009-BT	0.080" - 0.250"/2 - 6mm (2 pt.)	5 heads, 1 handle, 3 rings	\$6,681.71	<b>\$6,014.00</b>
54-567-010-BT	0.250" - 0.375"/6 - 10mm	2 heads, 1 handle, 1 ring	\$2,619.98	<b>\$2,358.00</b>
54-567-020-BT	0.375" - 0.750"/10 - 20mm	3 heads, 1 handle, 2 rings	\$3,387.72	<b>\$3,049.00</b>
54-567-050-BT	0.750" - 2"/20 - 50mm	3 heads, 1 handle, 2 rings	\$4,374.24	<b>\$3,937.00</b>
54-567-100-BT	2" - 4"/50 - 100mm	3 heads, 1 handle, 2 rings	\$4,636.93	<b>\$4,174.00</b>
54-567-105-BT	4" - 6"/100 - 150mm	2 heads, 1 handle, 1 ring	\$4,374.24	<b>\$3,937.00</b>
54-567-110-BT	6" - 8"/150 - 200mm	2 heads, 1 handle, 1 ring	\$5,223.97	<b>\$4,702.00</b>
54-567-200-BT	4" - 8"/100 - 200mm	4 heads, 1 handle, 2 rings	\$9,138.94	<b>\$8,226.00</b>
54-567-210-BT	0.750" - 4"/20 - 100mm	6 heads, 1 handle, 4 rings	\$7,118.38	<b>\$6,407.00</b>
54-567-620-BT	0.250" - 0.750"/6 - 20mm	5 heads, 1 handle, 3 rings	\$4,037.50	<b>\$3,634.00</b>
<b>Connectivity Cables/Accessory</b>				
54-115-526-0	Proximity cable with USB connection		\$223.37	<b>\$202.00</b>
54-115-527-0	Proximity cable with serial connection		\$216.29	<b>\$195.00</b>
54-115-246-BT	USB bluetooth receiver		\$49.45	<b>\$43.00</b>

# Bore Gaging Systems



## XTD3 Bluetooth Electronic Holemikes

**BIGGEST SALE EVER**

### Features:

- Coolant proof, dust proof - IP67
- Resolution: 0.00005"/0.001mm
- Bluetooth connectivity to your phone or tablet
- Self centering 3 point heads above 0.250"
- Tungsten carbide measuring faces on all 3-point heads from 0.5"/12.5mm and up
- Sizes over 0.500"/12.5mm feature blind bore capability
- Includes UKAS certificates for all pistol grip, heads and rings



BOWERS GROUP



Order No.	Range	Includes	List Price	Sale Price
<b>Holemike Individual Sets (Traditional style)</b>				
<b>2-Point Heads</b>				
54-367-003-BT	0.080" - 0.100"/2 - 2.5mm	1 head, 1 handle, 1 ring	\$2,643.30	<b>\$2,403.00</b>
54-367-004-BT	0.100" - 0.120"/2.5 - 3mm	1 head, 1 handle, 1 ring	\$2,643.30	<b>\$2,403.00</b>
54-367-005-BT	0.120" - 0.160"/3 - 4mm	1 head, 1 handle, 1 ring	\$2,643.30	<b>\$2,403.00</b>
54-367-006-BT	0.160" - 0.200"/4 - 5mm	1 head, 1 handle, 1 ring	\$2,643.30	<b>\$2,403.00</b>
54-367-007-BT	0.200" - 0.250"/5 - 6mm	1 head, 1 handle, 1 ring	\$2,643.30	<b>\$2,403.00</b>
<b>3-Point Heads</b>				
54-367-008-BT	0.250" - 0.312"/6 - 8mm	1 head, 1 handle, 1 ring	\$1,437.70	<b>\$1,307.00</b>
54-367-011-BT	0.312" - 0.375"/8 - 10mm	1 head, 1 handle, 1 ring	\$1,669.80	<b>\$1,518.00</b>
54-367-012-BT	0.375" - 0.500"/10 - 12.5mm	1 head, 1 handle, 1 ring	\$1,685.20	<b>\$1,532.00</b>
54-367-014-BT	0.500" - 0.625"/12.5 - 16mm	1 head, 1 handle, 1 ring	\$1,835.90	<b>\$1,669.00</b>
54-367-016-BT	0.625" - 0.750"/16 - 20mm	1 head, 1 handle, 1 ring	\$1,835.90	<b>\$1,669.00</b>
54-367-018-BT	0.750" - 1"/20 - 25mm	1 head, 1 handle, 1 ring	\$1,879.90	<b>\$1,709.00</b>
54-367-021-BT	1" - 1.375"/25 - 35mm	1 head, 1 handle, 1 ring	\$1,879.90	<b>\$1,709.00</b>
54-367-022-BT	1.375" - 2"/35 - 50mm	1 head, 1 handle, 1 ring	\$1,923.90	<b>\$1,749.00</b>
54-367-024-BT	2" - 2.625"/50 - 65mm	1 head, 1 handle, 1 ring	\$2,106.50	<b>\$1,915.00</b>
54-367-026-BT	2.625" - 3.250"/65 - 80mm	1 head, 1 handle, 1 ring	\$2,106.50	<b>\$1,915.00</b>
54-367-028-BT	3.250" - 4"/80 - 100mm	1 head, 1 handle, 1 ring	\$2,165.90	<b>\$1,969.00</b>
54-367-030-BT	4" - 5"/100 - 125mm	1 head, 1 handle, 1 ring	\$2,901.80	<b>\$2,638.00</b>
54-367-032-BT	5" - 6"/125 - 150mm	1 head, 1 handle, 1 ring	\$2,933.70	<b>\$2,667.00</b>
54-367-034-BT	6" - 7"/150 - 175mm	1 head, 1 handle, 1 ring	\$3,082.20	<b>\$2,802.00</b>
54-367-036-BT	7" - 8"/175 - 200mm	1 head, 1 handle, 1 ring	\$3,219.70	<b>\$2,927.00</b>
54-367-037-BT	8" - 9"/200 - 225mm	1 head, 1 handle, 1 ring	\$3,429.80	<b>\$3,118.00</b>
54-367-038-BT	9" - 10"/225 - 250mm	1 head, 1 handle, 1 ring	\$3,503.50	<b>\$3,185.00</b>
54-367-039-BT	10" - 11"/250 - 275mm	1 head, 1 handle, 1 ring	\$3,625.60	<b>\$3,296.00</b>
54-367-040-BT	11" - 12"/275 - 300mm	1 head, 1 handle, 1 ring	\$3,683.90	<b>\$3,349.00</b>
<b>Holemike Complete Sets (Traditional style)</b>				
54-367-000-BT	0.080" - 0.250"/2 - 6mm (2 pt.)	5 heads, 1 handle, 3 rings	\$4,545.20	<b>\$4,132.00</b>
54-367-010-BT	0.250" - 0.375"/6 - 10mm	2 heads, 1 handle, 1 ring	\$2,670.76	<b>\$2,430.00</b>
54-367-020-BT	0.375" - 0.750"/10 - 20mm	3 heads, 1 handle, 2 rings	\$3,187.03	<b>\$2,899.00</b>
54-367-050-BT	0.750" - 2"/20 - 50mm	3 heads, 1 handle, 2 rings	\$4,326.12	<b>\$3,935.00</b>
54-367-100-BT	2" - 4"/50 - 100mm	3 heads, 1 handle, 2 rings	\$4,791.89	<b>\$4,360.00</b>
54-367-105-BT	4" - 6"/100 - 150mm	2 heads, 1 handle, 1 ring	\$3,818.10	<b>\$3,471.00</b>
54-367-110-BT	6" - 8"/150 - 200mm	2 heads, 1 handle, 1 ring	\$5,034.70	<b>\$4,577.00</b>
54-367-200-BT	4" - 8"/100 - 200mm	4 heads, 1 handle, 2 rings	\$8,332.50	<b>\$7,575.00</b>
<b>Connectivity Cables/Accessory</b>				
54-115-526-0	Proximity cable with USB connection		\$223.37	<b>\$202.00</b>
54-115-527-0	Proximity cable with serial connection		\$216.29	<b>\$195.00</b>
54-115-246-BT	USB bluetooth receiver		\$49.45	<b>\$43.00</b>

Prices & Specifications are subject to change without notice.

**XT-Series Holemikes**

Vernier Bore Micrometers

**Features:**

- 3-pt contact with tungsten carbide measuring anvils above 0.5"
- Blind bore measuring heads featured above 0.5"
- Ratchet stop for consistent measuring
- Extensions available for deep measuring
- Includes UKAS certificates for all Holemikes and setting rings



Order No.	Range	Grads.	Meas. Accuracy	Ring Depth	Ring Included	List Price	Sale Price
52-255-310-0	0.250" - 0.312"	0.00025"	0.00015"	2.28"	0.312"	\$829.07	<b>\$622.00</b>
52-255-311-0	0.312" - 0.375"	0.00025"	0.00015"	2.28"	0.312"	\$767.67	<b>\$576.00</b>
52-255-312-0	0.375" - 0.500"	0.00025"	0.00015"	2.28"	0.5"	\$767.67	<b>\$576.00</b>
52-255-313-0	0.500" - 0.625"	0.00025"	0.00015"	2.44"	0.5"	\$767.67	<b>\$576.00</b>
52-255-314-0	0.625" - 0.750"	0.00025"	0.00015"	2.44"	0.75"	\$787.25	<b>\$591.00</b>
52-255-315-0	0.750" - 1"	0.00025"	0.00015"	2.60"	0.75"	\$864.56	<b>\$649.00</b>
52-255-316-0	1" - 1.375"	0.00025"	0.00015"	2.60"	1.375"	\$1,231.87	<b>\$924.00</b>
52-255-317-0	1.375" - 2"	0.00025"	0.00015"	3.15"	1.375"	\$1,261.24	<b>\$946.00</b>
52-255-318-0	2" - 2.625"	0.00025"	0.0002"	3.15"	2.625"	\$1,504.52	<b>\$1,129.00</b>
52-255-319-0	2.625" - 3.250"	0.00025"	0.0002"	3.15"	2.625"	\$1,517.98	<b>\$1,139.00</b>
52-255-320-0	3.250" - 4"	0.00025"	0.0002"	3.94"	3.25"	\$1,893.75	<b>\$1,421.00</b>
Sets							
52-255-565-0	0.250" - 0.375"	2 heads, 2 handles, 1 ring				\$1,686.00	<b>\$1,265.00</b>
52-255-665-0	0.375" - 0.750"	3 heads, 3 handles, 2 rings				\$2,096.32	<b>\$1,573.00</b>
52-255-775-0	0.750" - 2"	3 heads, 3 handles, 2 rings				\$3,293.82	<b>\$2,471.00</b>
52-255-885-0	2" - 4"	3 heads, 3 handles, 2 rings				\$4,465.29	<b>\$3,349.00</b>

# Bowers Ultima Bore Gaging System

World's most accurate system!



D62S

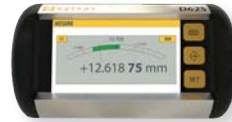

Display not included



### Features:

- Accuracies of 0.00004" up to 1.97"
- Ceramic anvils with blind bore capabilities above 0.472"
- Uses compact, multi function Sylvac display

Order No.	Description	Set Includes	List Price	Sale Price
54-565-006-1	0.078" - 0.236"/2 - 6mm	Includes: handle, rings & heads	\$7,642.60	<b>\$6,497.00</b>
54-565-010-1	0.236" - 0.393"/6 - 10mm	Includes: handle, rings & heads	\$4,150.90	<b>\$3,529.00</b>
54-565-020-1	0.393" - 0.787"/10 - 20mm	Includes: handle, rings & heads	\$6,175.54	<b>\$5,250.00</b>
54-565-070-1	0.236" - 0.787"/6 - 20mm	Includes: handle, rings & heads	\$9,658.72	<b>\$7,727.00</b>
54-565-080-1	0.787" - 1.97"/20 - 50mm	Includes: handle, rings & heads	\$10,589.24	<b>\$8,472.00</b>
54-565-090-1	1.97" - 3.94"/50 - 100mm	Includes: handle, rings & heads	\$11,758.98	<b>\$9,408.00</b>
54-565-100-1	0.787" - 3.94"/20 - 100mm	Includes: handle, rings & heads	\$18,007.01	<b>\$16,207.00</b>
Digital Displays				
54-618-106-2	Sylvac D62S Digital Display		\$1,535.33	<b>\$1,382.00</b>
54-618-106-3	Sylvac D62S Advanced Digital Display		\$1,982.16	<b>\$1,884.00</b>

## MicroGage

Pocket sized 2-point bore gaging system.



Replaces 100's of pin gages!



### Features:

- System range : 0.040" - 0.250"/1 - 6mm
- Switchable resolution 0.0005", 0.00005"/0.01, 0.001, 0.0005mm
- Repeatability : 0.00005"/0.001mm
- Sets include setting rings with UKAS certificates
- Depth stops available, call our technical department 1-800-788-2353

Order No.	Description	List Price	Sale Price
54-551-010-0	0.037" - 0.096"/0.95 - 2.45mm	\$3,950.93	<b>\$3,556.00</b>
54-551-011-0	0.060" - 0.167"/1.5 - 4.25mm	\$3,866.75	<b>\$3,481.00</b>
54-551-012-0	0.089" - 0.250"/2.25 - 6.35mm	\$4,162.44	<b>\$3,747.00</b>
Connectivity Cables			
54-115-526-0	Proximity cable with USB connection	\$223.37	<b>\$202.00</b>
54-115-527-0	Proximity cable with serial connection	\$216.29	<b>\$195.00</b>

Prices & Specifications are subject to change without notice.

# XTENDER Electronic Bore Gage Set

with Carbide Anvils

Industry's two most popular bore gage ranges combined in one easy-to-use electronic set!

Preset size of master for absolute reading and use minimum hold feature to lock on the bore size as the gage is rocked in the part to be measured.



#### Bore Gage features:

- Range: 1.4"-6"/35mm-150mm
- Carbide anvils
- Self-centering

#### Indicator features:

- Bar graph for reversal point indication
- Preset with recall
- ABS/INC measurement
- Min/Max/TIR



Use with Bore Gage Setting Master Kits, page 15.

Order No.	Range	Resolution	List Price	Sale Price
54-646-401-0	1.4 - 6"/35 - 150mm	0.00005"/0.001mm	\$420.79	<b>\$358.00</b>
Extensions				
52-646-450-0	20" depth extension		\$108.40	<b>\$98.00</b>
52-646-475-0	40" depth extension		\$121.82	<b>\$110.00</b>

## Dial Cylinder Bore Gages

2-point bore measuring



52-646-300-0

#### Features:

- Carbide Anvils
- Easy-to-read
- Great value
- Graduation: 0.0005", 0.0001" or 0.01mm
- Insulated grip
- 9.5" depth above 1.5"
- Chrome plated handle

# XTENDER



52-646-400-0

Use with Bore Gage Setting Master Kits, page 15.

Order No.	Range	Graduation	List Price	Sale Price
52-646-100-0	0.7" - 1.5"	0.0005"	\$169.38	<b>\$128.00</b>
52-646-300-0	2" - 6"	0.0005"	\$160.27	<b>\$137.00</b>
52-646-400-0	1.4" - 6"	0.0005"	\$212.85	<b>\$160.00</b>
52-646-500-0	1.4" - 6"	0.0001"	\$276.34	<b>\$235.00</b>
52-646-220-0	35 - 60mm	0.01mm	\$277.40	<b>\$236.00</b>
Extensions				
52-646-450-0	20" depth extension	<i>*Not for use with 52-646-100-0</i>	\$108.40	<b>\$98.00</b>
52-646-475-0	40" depth extension	<i>*Not for use with 52-646-100-0</i>	\$121.82	<b>\$110.00</b>

# Internal & External Electronic Caliper Gages

For grooves and recesses.



54-554-611-0



54-554-711-0

## Features:

- Accuracy:  $\pm 0.0008'' \pm 0.02\text{mm}$
- Resolution:  $0.0002''/0.005\text{mm}$
- Analog scale for reversal point indication
- Large, LCD display
- Preset capability
- Absolute and incremental measurements modes
- High-impact, aircraft aluminum case
- Rugged housing

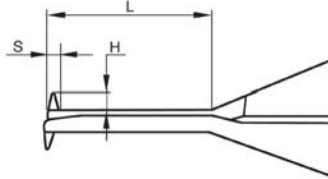

## Dimensions for Internal Calipers

Metric	Inch	L	S	H	Tip Radius
5-15mm	0.2-0.6"	20mm	1.0mm	1.5mm	0.3mm
5-25mm	0.2-1.0"	35mm	1mm	1.5mm	0.3mm
10-30mm	0.4-1.2"	55mm	2mm	3.5mm	0.5mm
20-40mm	0.8-1.6"	80mm	3mm	6.5mm	0.5mm
30-50mm	1.2-2.0"	80mm	3mm	8.5mm	0.5mm

## Dimensions for External Calipers

Metric	Inch	L	S	H	Tip Radius
0-10mm	0-0.4"	40mm	3mm	8mm	0.5mm
0-20mm	0-0.8"	80mm	6.5mm	25mm	0.75mm
10-30mm	0.4-1.2"	80mm	6.5mm	25mm	0.75mm
20-40mm	0.8-1.6"	80mm	6.5mm	25mm	0.75mm
30-50mm	1.2-2.0"	80mm	6.5mm	25mm	0.75mm

Order No.	Range	List Price	Sale Price
<b>Internal Caliper Gages</b>			
54-554-611-0	0.200" - 0.590"/5 - 15mm	\$207.50	<b>\$177.00</b>
54-554-622-0	0.200" - 1"/5 - 25mm	\$222.49	<b>\$190.00</b>
54-554-623-0	0.400" - 1.2"/10 - 30mm	\$232.88	<b>\$198.00</b>
54-554-624-0	0.790" - 1.6"/20 - 40mm	\$266.51	<b>\$227.00</b>
54-554-625-0	1.2" - 2"/30 - 50mm	\$266.51	<b>\$227.00</b>
<b>External Caliper Gages</b>			
54-554-711-0	0 - 0.400"/0 - 10mm	\$237.48	<b>\$202.00</b>
54-554-722-0	0 - 0.790"/0 - 20mm	\$254.63	<b>\$217.00</b>
54-554-723-0	0.4" - 1.2"/10 - 30mm	\$266.51	<b>\$227.00</b>
54-554-724-0	0.790" - 1.6"/20 - 40mm	\$266.51	<b>\$227.00</b>
54-554-725-0	1.2" - 2"/30 - 50mm	\$232.88	<b>\$198.00</b>

## Bore Gage Setting Master Kits - Inch & Metric

Fowler's Bore Gage Setting Master Kit is used for accurately setting any 2 point cylinder bore gage up to 6"/150mm in diameter to an accuracy of 0.0001"/0.003mm



### Each Set includes: Setting Device

- Base anvil: 3.950" x 1.050"
- Adjustable anvil 2.375" x .375" (two each)
- Internal capacity: 6"/150mm
- Centralizer capacity width: 2.750"
- Quick-release holder for fast adjustment

### Economy Gage Block Sets

#### Inch model:

- 36 piece
- Tolerances to .00005"
- Certificate of Calibration to NIST

#### Metric model:

- 33 piece
- AS-2 grade
- Certificate of Calibration to NIST

Bore gage shown not included

### Includes:

**Bore gage setting master and gage block set!**  
**All in a custom-fitted case!**

Order No.	Description	List Price	Sale Price
53-646-000-1	Inch Bore Gage Setting Master Kit	\$400.72	<b>\$341.00</b>
53-646-010-0	Metric Bore Gage Setting Master Kit	\$407.18	<b>\$347.00</b>
53-646-005-0	Bore Gage Setting Master Kit - <b>without</b> Gage Blocks	\$247.69	<b>\$211.00</b>

## Electronic Calipers Comparison Chart

	Data Output	Wireless	IP Rating	IN/MM/Frac.	Sizes
Ultra-Cal VI Calipers	✓	✓	IP67	—	6", 8", 12"
Ultralight IV Calipers	✓	✓	IP67	—	15", 24", 40", 60", 80", 100"
IP67 Calipers	✓	✓	IP67	—	6", 12"
Digital Calipers	✓	✓	IP40	—	4", 6", 8", 12"
Carbon Fiber Calipers	✓	—	IP65	—	24", 40", 60"
Xtra-Range Calipers	✓	—	IP54	—	12", 24"
Xtra-Value PLUS Calipers	—	—	IP54	✓	6", 12"
Xtra-Value Calipers	—	—	—	—	6", 8", 12"

## Swiss Ultralight IV Electronic Calipers

When you have **HUGE** parts to measure, this is the caliper you need!



### Features:

- IP67 protected against fluid and dust
- Built-in Bluetooth
- Reinforced frame
- XXL display with 0.79"/20mm high digits
- Lengthened jaws 7.9"/200mm
- Includes upper ID measuring pins (5mm dia.)
- Movable left jaw
- Stainless steel titanium coated jaws
- Hold feature
- Preset function
- Min/Max functions
- Tolerance mode
- Internal and external measurement indicator



Alternative jaws available, contact the Fowler Technical Department for more information 1-800-788-2353

Order No.	Range	Accuracy	List Price	Sale Price
54-110-512-0	0 - 15"/0 - 400mm	0.0012"/30 $\mu$ m	\$2,532.88	<b>\$2,153.00</b>
54-110-524-0	0 - 24"/0 - 600mm	0.0016"/40 $\mu$ m	\$3,016.86	<b>\$2,565.00</b>
54-110-540-0	0 - 40"/0 - 1000mm	0.002"/50 $\mu$ m	\$3,474.34	<b>\$2,954.00</b>
54-110-560-0	0 - 60"/0 - 1500mm	0.0035"/90 $\mu$ m	\$4,564.28	<b>\$3,880.00</b>
54-110-580-0	0 - 80"/0 - 2000mm - <i>special order</i>	0.0048"/120 $\mu$ m	\$7,048.49	<b>\$5,992.00</b>
54-110-600-0	0 - 100"/0 - 2500mm - <i>special order</i>	0.0078"/200 $\mu$ m	\$8,585.95	<b>\$7,299.00</b>
Connectivity Cables/Accessories				
54-981-713-2	Sylcom Basic Data Processing Software		\$810.68	<b>\$771.00</b>
54-115-526-0	Proximity USB Cable		\$223.37	<b>\$202.00</b>
54-115-527-0	Proximity Serial Cable		\$216.29	<b>\$195.00</b>
54-115-246-BT	USB Bluetooth Receiver		\$49.45	<b>\$43.00</b>



# Swiss Ultra-Cal VI Electronic Calipers

3 styles to suit your needs.



54-100-167-0



54-100-444-1



## Features:

- IP67 protected against fluid and dust
- Available with Bluetooth, proximity cable or no SPC output
- Heavy duty frame
- Extra large display
- Available with ISO Cert
- 12"/300mm is supplied without depth rod



**Calibration certificates available for all sizes.**

Order No.	Range	Accuracy	Resolution	List Price	Sale Price
Bluetooth Communication					
54-100-167-0	6"/150mm	0.0008"/20µm	0.0005"/0.01mm	\$425.08	<b>\$383.00</b>
54-100-168-0	8"/200mm	0.0012"/30µm	0.0005"/0.01mm	\$725.47	<b>\$653.00</b>
54-100-169-0	12"/300mm	0.0012"/30µm	0.0005"/0.01mm	\$886.25	<b>\$754.00</b>
Proximity Cable Communication					
54-100-444-1	6"/150mm	0.0008"/20µm	0.0005"/0.01mm	\$196.06	<b>\$177.00</b>
54-100-448-1	8"/200mm	0.0012"/30µm	0.0005"/0.01mm	\$439.69	<b>\$396.00</b>
54-100-412-1	12"/300mm	0.0012"/30µm	0.0005"/0.01mm	\$593.05	<b>\$534.00</b>
Without Data Output					
54-100-177-0	6"/150mm	0.0008"/20µm	0.0005"/0.01mm	\$169.18	<b>\$153.00</b>
54-100-178-0	8"/200mm	0.0012"/30µm	0.0005"/0.01mm	\$398.79	<b>\$359.00</b>
54-100-179-0	12"/300mm	0.0012"/30µm	0.0005"/0.01mm	\$460.06	<b>\$415.00</b>
Connectivity Cables/Accessories					
54-981-713-2	Sylcom Basic Data Processing Software			\$810.68	<b>\$771.00</b>
54-115-526-0	Proximity cable with USB Connection			\$223.37	<b>\$202.00</b>
54-115-527-0	Proximity cable with Serial Connection			\$216.29	<b>\$195.00</b>
54-115-246-BT	USB Bluetooth Receiver			\$49.45	<b>\$43.00</b>

Prices & Specifications are subject to change without notice.

# IP67 Electronic Calipers

Smart Wireless Communication to most phones or tablets.



54-100-556-BT



**Features:**

- IP67 protected against fluid and dust
- Wireless connectivity for quick error free data collection
- Supplied with NIST certification
- Heavy duty frame with 4-way measuring, inside, outside, depth and step
- Super large display
- Includes fitted case, extra battery tray and a 1" setting standard

Order No.	Range	Accuracy	List Price	Sale Price
54-100-556-BT	0 - 6"/150mm	0.001"/0.02mm	\$211.23	<b>\$191.00</b>
54-100-512-BT	0 - 12"/300mm	0.0015"/0.04mm	\$259.53	<b>\$234.00</b>

# XTRA-VALUE Plus Electronic Calipers

IP54 protected with inch/metric/fractions.



**Features:**

- Range: 6"/150mm
- Accuracy:  $\pm 0.001"/0.02mm$
- Inch/Metric/Fraction reading: 0.0005"/0.01mm/ 1/128"
- Heavy Duty frame for extra rigidity and wear resistance
- Super large, easy to read display
- Includes fitted case

Order No.	Range	Accuracy	List Price	Sale Price
54-103-006-0	0 - 6"/150mm	0.001"/0.02mm	\$98.98	<b>\$80.00</b>
54-103-012-0	0 - 12"/300mm	0.0015"/0.03mm	\$149.79	<b>\$128.00</b>

# Electronic Calipers

Absolute location retention after shut off.



54-100-000-2

#### Features:

- Resolution: 0.0005"/0.01mm
- Absolute/Incremental Measurement
- Stainless steel frame
- Direct Inch/Metric conversion
- 4-way measuring, inside, outside, depth and step
- Wireless SPC data option
- Includes fitted case

Order No.	Range	Accuracy	List Price	Sale Price
54-100-004-2	4"/100mm	0.001"/0.02mm	\$143.24	<b>\$122.00</b>
54-100-000-2	6"/150mm	0.001"/0.02mm	\$161.96	<b>\$146.00</b>
54-100-008-2	8"/200mm	0.0015"/0.04mm	\$164.57	<b>\$140.00</b>
54-100-112-2	12"/300mm	0.0015"/0.04mm	\$226.48	<b>\$193.00</b>
Accessories				
54-115-100-0	Wireless transmitter		\$119.81	<b>\$114.00</b>

## XTRA-VALUE CAL Electronic Calipers

Value priced verniers.



54-101-150-2



54-101-300-1



#### Features:

- Stainless steel frame
- Large easy-to-read display
- Resolution: 0.0005"/0.01mm
- Absolute/Incremental measurement
- 4-way measuring, inside, outside, depth and step
- 6" and 12" regular display models include NIST Cert.
- Includes fitted case

Order No.	Range	Accuracy	List Price	Sale Price
54-101-150-2	6"/150mm - Regular Display	0.001"/0.02mm	\$54.93	<b>\$47.00</b>
54-101-600-1	6"/150mm - Large Display with Hold feature	0.0015"/0.04mm	\$75.61	<b>\$65.00</b>
54-101-200-1	8"/200mm - Regular Display	0.0015"/0.04mm	\$102.30	<b>\$87.00</b>
54-101-300-1	12"/300mm - Regular Display	0.0015"/0.04mm	\$125.47	<b>\$107.00</b>
54-101-900-1	12"/300mm - Large Display with Hold feature	0.0015"/0.04mm	\$165.55	<b>\$141.00</b>

Prices & Specifications are subject to change without notice.

# XTRA-RANGE® Carbon Fiber Electronic Calipers



54-100-140-0

## Features:

- IP65 protected against fluid and dust
- Lightweight carbon fiber frame
- Stainless steel jaws with ID nibs
- ID/OD pressure device for repeatability
- USB data output (works with 54-520-399-0)
- Preset, ABS/INC, Floating zero, IN/MM, Hold function
- Super large display
- Fitted wooden case

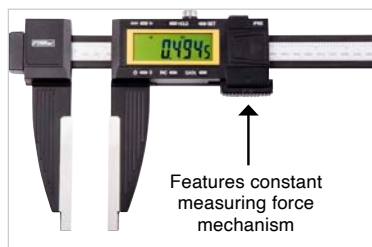

Features constant measuring force mechanism

Order No.	Range	Accuracy	Jaw Depth	Weight	List Price	Sale Price
54-100-124-0	0 - 24"/600mm	0.0020"/0.05mm	5.4"/138mm	2.85 lbs.	\$825.00	<b>\$743.00</b>
54-100-140-0	0 - 40"/1000mm	0.0025"/0.06mm	5.4"/138mm	3.45 lbs.	\$1,495.00	<b>\$1,346.00</b>
54-100-160-0	0 - 60"/1500mm	0.0055"/0.13mm	5.9"/150mm	4.4 lbs.	\$1,995.00	<b>\$1,796.00</b>

# XTRA-RANGE® Electronic Calipers

For large measurements

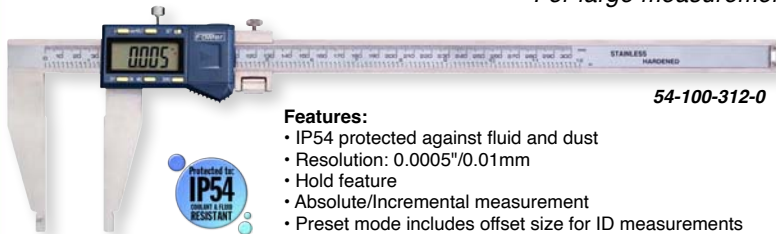

54-100-312-0

## Features:

- IP54 protected against fluid and dust
- Resolution: 0.0005"/0.01mm
- Hold feature
- Absolute/Incremental measurement
- Preset mode includes offset size for ID measurements
- Both sizes feature fine adjustment

Order No.	Range	Accuracy	Jaw Depth	List Price	Sale Price
54-100-312-0	0 - 12"/300mm	± 0.002"/0.05mm	3.5"	\$266.67	<b>\$241.00</b>
54-100-024-1	0 - 24"/600mm	± 0.003"/0.075mm	4"	\$412.94	<b>\$372.00</b>

# XTRA-RANGE® Dial Calipers

With full length depth rod



52-008-018-0

## Features:

- Graduations: 0.001"
- Jaw depth: 3.125"
- Stainless steel construction
- Satin chrome finish
- Full length depth rod
- 0.50" internal measuring nibs on jaws

Order No.	Range	Accuracy	List Price	Sale Price
52-008-018-0	0 - 18"	± 0.003"	\$292.39	<b>\$234.00</b>
52-008-024-0	0 - 24"	± 0.003"	\$354.32	<b>\$302.00</b>

# Premium Grade Dial Calipers

With mono-block housing for added protection.



24.1



52-008-706-0



52-008-707-0

### Features:

- Tough shockproof gearing with ultra smooth movement
- 4-way measuring, inside, outside, depth and step
- Inverted/covered rack
- Solid stainless steel construction with lapped measuring faces
- 0.100" range per revolution
- 0.001" reading dial

Order No.	Range	Dial Color	Accuracy	List Price	Sale Price
52-008-704-1	0 - 0"	White	± 0.001"	\$90.00	<b>\$77.00</b>
52-008-714-1	0 - 0"	Black	± 0.001"	\$90.00	<b>\$77.00</b>
52-008-706-0	0 - 6"	White	± 0.001"	\$102.74	<b>\$88.00</b>
52-008-707-0	0 - 6"	Black	± 0.001"	\$102.74	<b>\$88.00</b>
52-008-708-0	0 - 8"	White	± 0.0015"	\$123.37	<b>\$105.00</b>
52-008-712-0	0 - 12"	White	± 0.002"	\$165.88	<b>\$141.00</b>
Metric					
52-008-709-0	0 - 150mm	Yellow	± 0.02mm	\$105.93	<b>\$91.00</b>

## Dial Calipers



52-008-005-1



52-008-007-1

### Features:

- 4-way measuring for outside, inside, depths and steps
- Graduation: 0.001"
- Hardened stainless steel throughout
- Covered rack
- Shockproof gearing

Order No.	Range	Dial Color	Accuracy	List Price	Sale Price
52-008-005-1	0 - 6"	Black	± 0.001"	\$85.00	<b>\$73.00</b>
52-008-007-1	0 - 6"	White	± 0.001"	\$85.00	<b>\$73.00</b>
52-008-008-1	0 - 8"	White	± 0.0015"	\$100.00	<b>\$85.00</b>
52-008-012-1	0 - 12"	White	± 0.002"	\$150.00	<b>\$128.00</b>

Calipers



## Electronic Micrometers Comparison Chart

	Data Output	Wireless	IP Rating	Sizes
RAPID-MIC Micrometers	✓	✓	IP67	0 - 4"
DIGI-MIC Micrometers		✓	IP67	0 - 1"
Xtra-MIC PLUS Mics.	✓	—	IP54	0 - 4"
Coolant Resistant Mics.	—	—	IP54	0 - 4"
Xtra-Value II Micrometers	—	—	IP40	0 - 4"

## Rapid-Mic Quick-Displacement Electronic Micrometers

*Fastest micrometer on the market!*



### Features:

- IP67 protected against fluid and dust
- Non-rotating spindle with 0.39"/10mm travel per thimble rotation
- Adjustable measuring force, 5N/10N (54-815-030-0 and 54-815-130-0 only)
- Menu customizable with free software
- **Larger sizes and specialty anvil micrometers also available**

**Calibration certificates available for all sizes.**

Order No.	Range	Accuracy	List Price	<i>Sale Price</i>
54-815-030-0	0 - 1.18"/0 - 30mm	0.00012"/0.003mm	\$625.88	<b>\$532.00</b>
54-815-060-0	1.18" - 2.6"/30 - 66mm	0.00016"/0.004mm	\$1,134.49	<b>\$1,022.00</b>
54-815-100-0	2.6" - 4.0"/66 - 102mm	0.00020"/0.005mm	\$1,237.69	<b>\$1,114.00</b>
Set				
54-815-111-0	0 - 4"/0 - 102mm		\$2,851.16	<b>\$2,424.00</b>
Bluetooth Models				
54-815-130-0	0 - 1.18"/0 - 30mm	0.00012"/0.003mm	\$986.19	<b>\$888.00</b>
54-815-160-0	1.18" - 2.6"/30 - 66mm	0.00016"/0.004mm	\$1,350.72	<b>\$1,216.00</b>
54-815-110-0	2.6" - 4.0"/66 - 102mm	0.00020"/0.005mm	\$1,398.24	<b>\$1,259.00</b>
Bluetooth Set				
54-815-112-0	0 - 4"/0 - 102mm		\$4,079.30	<b>\$3,672.00</b>
Connectivity Cables/Accessories				
54-981-713-2	Sylcom Basic Data Processing Software		\$810.68	<b>\$771.00</b>
54-981-724-5	Sylcom Pro Data Processing Software		\$1,939.95	<b>\$1,843.00</b>
54-115-526-0	Proximity cable with USB connection		\$223.37	<b>\$202.00</b>
54-115-527-0	Proximity cable with serial connection		\$216.29	<b>\$195.00</b>
54-115-246-BT	USB Bluetooth receiver		\$49.45	<b>\$43.00</b>

# DigiMic Electronic Micrometer

The world standard of precision with IP67 and Bluetooth®.



24.1



### Features:

- IP67 protected against fluid and dust
- Very High Accuracy: 0.00008"/0.002mm (0-1"/25mm)
- Bluetooth IOT ready, no dongle or cable required for SPC data collection
- Carbide measuring surfaces, sleep and absolute modes



Order No. 54-816-025-0

Calibration certificate available.

**Sale \$754.00**

List Price \$886.83

## XTRA-MIC PLUS Electronic Micrometers



54-880-001-0

**25% off**

Limited quantities



### Features:

- IP54 protected against fluid and dust
- Super large LCD display, 14mm height
- Resolution: 0.00005"/0.001mm
- Carbide tipped anvil and spindle



Order No.	Range	Accuracy	List Price	Sale Price
54-880-001-0	0 - 1"/0 - 25mm	0.00016"/0.004mm	\$152.25	<b>\$115.00</b>
54-880-002-0	1 - 2"/25 - 50mm	0.00016"/0.004mm	\$202.78	<b>\$153.00</b>
54-880-003-0	2 - 3"/50 - 75mm	0.0002"/0.005mm	\$216.78	<b>\$163.00</b>
54-880-004-0	3 - 4"/75 - 100mm	0.0002"/0.005mm	\$215.11	<b>\$162.00</b>
Set				
54-880-103-0	0 - 3"/0 - 75mm		\$511.18	<b>\$384.00</b>

## Electronic IP54 Blade Micrometers



54-860-241-0

### Features:

- IP54 protected against fluid and dust
- Blades are 0.030" thick x 0.255" long
- Accuracy: 0.00016"
- Resolution: 0.00005"/0.001mm
- Friction thimble



Order No.	Range	List Price	Sale Price
54-860-241-0	0 - 1" Blade Anvil	\$300.90	<b>\$241.00</b>
54-860-242-0	1" - 2" Blade Anvil with standard	\$374.04	<b>\$300.00</b>

Micrometers



## Electronic Coolant Resistant Micrometers

For basic outside measurements with higher protection.



### Features:

- IP54 protected against fluid and dust
- Resolution: 0.00005"/0.001mm
- Carbide measuring faces
- Absolute & incremental modes
- Ratchet thimble
- Automatic switch off
- Free ball attachment included
- Sizes over 1"/25mm include a calibration standard

Order No.	Range	Accuracy	List Price	Sale Price
54-860-001-1	0 - 1"/0 - 25mm	± 0.00016"/0.004mm	\$157.13	<b>\$126.00</b>
54-860-002-1	1 - 2"/25 - 50mm w/standard	± 0.00016"/0.004mm	\$181.88	<b>\$146.00</b>
54-860-003-1	2 - 3"/50 - 75mm w/standard	± 0.0002"/0.005mm	\$171.63	<b>\$138.00</b>
54-860-004-1	3 - 4"/75 - 100mm w/standard	± 0.0002"/0.005mm	\$210.33	<b>\$169.00</b>
Set				
54-860-103-1	0 - 3"/0 - 75mm w/standard		\$516.67	<b>\$414.00</b>

## XTRA-VALUE II Electronic Micrometers



### Features:

- IP40 protected against fluid and dust
- Resolution: 0.00005"/0.001mm
- Carbide measuring faces
- Absolute and incremental modes
- Ratchet thimble
- Free ball attachment included
- Sizes over 1"/25mm include a calibration standard

Order No.	Range	Accuracy	List Price	Sale Price
54-870-001-0	0 - 1"/0 - 25mm	± 0.00016"/0.004mm	\$107.28	<b>\$86.00</b>
54-870-002-0	1" - 2"/25 - 50mm	± 0.00016"/0.004mm	\$115.85	<b>\$93.00</b>
54-870-003-0	2" - 3"/50 - 75mm	± 0.0002"/0.005mm	\$138.56	<b>\$111.00</b>
54-870-004-0	3" - 4"/75 - 100mm	± 0.0002"/0.005mm	\$169.62	<b>\$136.00</b>
Set				
54-870-103-0	0 - 3"/0 - 75mm		\$346.42	<b>\$278.00</b>



# Digit Counter Micrometers

0.001" digit counter.



52-224-001-1

**Features:**

- Digital counter reads to 0.001"
- Graduations: 0.0001" (using vernier)
- Microfine graduations on satin chrome
- Carbide tipped measuring faces
- Sizes over 1"/25mm include a standard
- Includes case

Order No.	Range	Accuracy	List Price	Sale Price
52-224-001-1	0 - 1"	0.00016"	\$125.49	<b>\$95.00</b>
52-224-002-1	1" - 2"	0.00016"	\$131.81	<b>\$93.00</b>
52-224-003-1	2" - 3"	0.0002"	\$150.11	<b>\$106.00</b>
52-224-004-1	3" - 4"	0.0002"	\$189.08	<b>\$133.00</b>
52-224-005-1	4" - 5"	0.00024"	\$174.84	<b>\$123.00</b>
52-224-006-1	5" - 6"	0.00024"	\$182.77	<b>\$128.00</b>
<b>Sets</b>				
52-224-103-0	0 - 3" set (set finished in grey enamel)		\$396.05	<b>\$278.00</b>
52-224-104-0	0 - 4" set (set finished in grey enamel)		\$561.68	<b>\$394.00</b>
52-224-220-0	0 - 75mm set (set finished in grey enamel)		\$417.03	<b>\$292.00</b>

# Digit Counter Ball Anvil Micrometers



52-244-201-1

**Features:**

- Microfine graduations on satin chrome
- Digital counter reads to 0.001", sleeve reads to 0.0001"
- Spindle hardened and precision ground with a carbide tipped measuring face
- Ratchet stop thimble
- Accuracy: 0.00016", Graduation: 0.0001"

Order No.	Range	List Price	Sale Price
52-244-201-1	0 - 1" Ball Anvil	\$135.88	<b>\$96.00</b>
52-244-301-1	1" - 2" Ball Anvil/Ball Spindle	\$164.99	<b>\$116.00</b>

# Digit Counter Disc Micrometers



Order No. 52-250-301-1

**Features:**

- Anvil and spindle are hardened and precision ground
- Flatness: 0.00004"
- Accuracy: 0.00016", Graduation: 0.0001"
- Disc edge thickness: 0.035", disc dia.: 0.708"
- Ratchet thimble
- The disc type anvil and spindle simplifies measuring the thickness of difficult, closely spaced sections

**Sale \$143.00**

List Price \$178.70



# Outside Vernier Micrometers

0.0001" graduations for higher accuracy.



52-240-001-1



52-215-003-1

### Features:

- Graduation: 0.0001"
- Microfine graduations on satin chrome finish and carbide tipped measuring faces
- Diameter of measuring faces: 0.256"
- Flatness: 0.00003"
- Spindle thread hardened, ground and lapped for ultimate accuracy
- Includes a wrench and case
- Sizes over 1"/25mm include a standard

Order No.	Range	Accuracy	Thimble	List Price	Sale Price
52-240-001-1	0 - 1"	± 0.00016"	Friction	\$45.94	<b>\$40.00</b>
52-240-101-1	0 - 1"	± 0.00016"	Ratchet	\$45.94	<b>\$40.00</b>
52-240-002-1	1" - 2"	± 0.00016"	Friction	\$53.42	<b>\$46.00</b>
52-240-102-1	1" - 2"	± 0.00016"	Ratchet	\$61.14	<b>\$52.00</b>
52-240-003-1	2" - 3"	± 0.0002"	Ratchet	\$62.42	<b>\$54.00</b>
52-240-004-1	3" - 4"	± 0.0002"	Ratchet	\$79.77	<b>\$68.00</b>
52-240-005-1	4" - 5"	± 0.00024"	Ratchet	\$88.35	<b>\$76.00</b>
52-240-006-1	5" - 6"	± 0.00024"	Ratchet	\$96.81	<b>\$83.00</b>
52-240-007-1	6" - 7"	± 0.00028"	Ratchet	\$105.26	<b>\$90.00</b>
52-240-008-1	7" - 8"	± 0.00028"	Ratchet	\$108.24	<b>\$93.00</b>
52-240-009-1	8" - 9"	± 0.00032"	Ratchet	\$123.02	<b>\$105.00</b>
52-240-010-1	9" - 10"	± 0.00032"	Ratchet	\$139.52	<b>\$119.00</b>
52-240-011-1	10" - 11"	± 0.00036"	Ratchet	\$154.30	<b>\$132.00</b>
52-240-012-1	11" - 12"	± 0.00036"	Ratchet	\$193.48	<b>\$165.00</b>
Sets					
52-215-003-1	0 - 3" with standards and fitted shop hardened case			\$183.19	<b>\$147.00</b>
52-215-004-1	0 - 4" with standards and fitted shop hardened case			\$262.46	<b>\$224.00</b>
52-215-006-1	0 - 6" with standards and fitted shop hardened case			\$445.54	<b>\$379.00</b>
52-215-012-1	0 - 12" with standards and fitted case			\$1,350.69	<b>\$1,149.00</b>
52-215-612-1	6 - 12" with standards and fitted case			\$891.07	<b>\$758.00</b>

# Outside Vernier Micrometers

0.001" readings.



52-253-001-1



### Features:

- Graduation: 0.001"
- Carbide tipped measuring faces
- Diameter of measuring faces: 0.256"
- Anvil & spindle hardened and precision ground with microlap finish on tips
- Sizes over 1"/25mm include a standard

Order No.	Range	Accuracy	Thimble	List Price	Sale Price
52-253-001-1	0 - 1"	± 0.001"	Friction	\$38.66	<b>\$33.00</b>
52-253-101-1	0 - 1"	± 0.001"	Ratchet	\$38.66	<b>\$33.00</b>
52-253-002-1	1" - 2"	± 0.001"	Friction	\$52.57	<b>\$45.00</b>
52-253-102-1	1" - 2"	± 0.001"	Ratchet	\$45.94	<b>\$40.00</b>
52-253-003-1	2" - 3"	± 0.001"	Ratchet	\$61.14	<b>\$52.00</b>
52-253-004-1	3" - 4"	± 0.001"	Ratchet	\$62.42	<b>\$54.00</b>
52-253-005-1	4" - 5"	± 0.001"	Ratchet	\$69.71	<b>\$60.00</b>
52-253-006-1	5" - 6"	± 0.001"	Ratchet	\$77.20	<b>\$66.00</b>

## Outside Vernier Micrometer Set

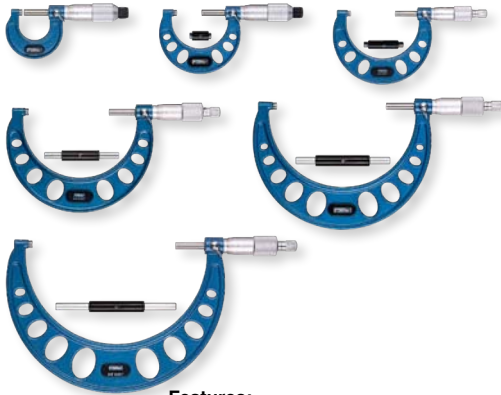

### Features:

- Range: 0 - 6"
- Carbide tipped measuring faces
- Graduation: 0.001"
- Diameter of measuring faces: 0.256"
- Anvil & spindle hardened and precision ground with microlap finish on tips
- Sizes over 1" include a standard

Order No. 52-253-600-1

**Sale \$302.00**

List Price \$354.40

## Electronic IP65 Thread Micrometers

For accurate pitch diameter measurements



54-219-001-0

### Features:

- IP65 protected against fluid and dust
- Thread range: 64 - 3.5 TPI/0.4 - 7mm
- Accuracy:  $\pm 0.00008$ "/0.002mm
- 60° measuring anvils
- Absolute and incremental measuring mode
- Resolution: 0.00005"/0.001mm
- Friction thimble

Order No.	Range	Thread Range	Accuracy	List Price	Sale Price
54-219-001-0	0 - 1"/0 - 25mm	64 - 5 TPI/0.4 - 5mm	$\pm 0.00008$ "/0.002mm	\$289.94	<b>\$261.00</b>
54-219-002-0	1" - 2"/25 - 50mm	44 - 3.5 TPI/0.6 - 7mm	$\pm 0.00008$ "/0.002mm	\$349.06	<b>\$315.00</b>

## Vernier Thread Micrometers



52-219-001-1

### Features:

- 60° measuring anvils
- Graduation: 0.001"
- Ratchet thimble
- Sizes over 1" include standard

Order No.	Range	Thread Range	Accuracy	List Price	Sale Price
52-219-001-1	0 - 1"	64 - 5 TPI/0.4 - 5mm	0.00016"	\$132.53	<b>\$120.00</b>
52-219-002-1	1" - 2"	44 - 3.5 TPI/0.6 - 7mm	0.00016"	\$127.49	<b>\$115.00</b>

## Micrometer Stands



52-247-005-0

### Features:

- Unique locking system adjusts micrometer stand to any position for perfect use and viewing
- Stand folds for storage

## XTRA MAG

### Features:

- Holds standard 0-12" micrometers firmly to metal surfaces
- Use at machine centers, assembly and inspection stations, steel tables and shelves
- V-bottom for mounting on cylindrical surfaces
- On/Off magnet switch
- Base is 2.30" L x 1.20" W x 3.50" H



52-247-010-0

Micrometer not included

Order No.	Description	List Price	Sale Price
52-247-005-0	Folding Micrometer Stand	\$43.79	<b>\$40.00</b>
52-247-010-0	Magnetic Micrometer Stand	\$77.47	<b>\$70.00</b>

# IP54 Electronic Depth Micrometer

## Features:

- IP54 protected against fluid and dust
- Range: 0 - 6"/150 mm
- Resolution: 0.00005"/0.001mm
- Base surface hardened and microlapped to 0.00008" flatness
- Rod diameter: 0.176"
- Includes fitted case



Order No. 54-225-456-0

**Sale \$226.00**

List Price \$250.54

# Digit Counter Depth Micrometers

## Features:

- Easy-to-read digit counter
- Microfine 0.001" graduations
- Base surface hardened and microlapped to 0.00008" flatness
- Ratchet thimble
- Rod diameter: 0.176"
- Includes wrench and fitted case



52-225-226-0

Order No.	Range	Graduation	Accuracy	Base Size	List Price	Sale Price
52-225-176-0	0 - 6"	0.001"	0.0002"	2.5"	\$219.24	<b>\$198.00</b>
52-225-226-0	0 - 6"	0.001"	0.0002"	4"	\$243.57	<b>\$208.00</b>

# Vernier Depth Micrometers

## Features:

- Base surface hardened and microlapped to 0.00008" flatness
- Ratchet thimble
- Locking clamp
- Rod diameter: 0.176"
- Includes fitted case

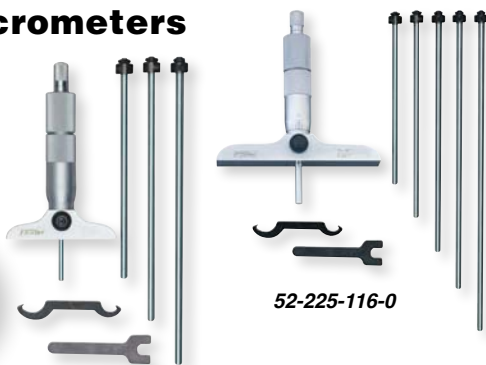

52-225-116-0

52-225-110-0

Order No.	Range	Graduation	Accuracy	Base Size	List Price	Sale Price
52-225-110-0	0 - 4"	0.001"	0.0002"	2.5"	\$157.43	<b>\$142.00</b>
52-225-112-0	0 - 6"	0.001"	0.0002"	2.5"	\$201.57	<b>\$182.00</b>
52-225-114-0	0 - 4"	0.001"	0.0002"	4"	\$161.14	<b>\$146.00</b>
52-225-116-0	0 - 6"	0.001"	0.0002"	4"	\$188.55	<b>\$170.00</b>
52-225-035-1	0 - 12"	0.001"	0.00028"	4"	\$434.39	<b>\$326.00</b>

## Electronic Indicators Comparison Chart

	Data Output	Wireless Option	IP Rating	IN/MM/Frac.
MARK VI Indicators	✓	✓	IP54	—
Mini-S Indicators	✓	✓	IP67	—
Quadra-TEST Indicators	✓	✓	IP65	—
Indi-X BT Indicators	—	✓	IP65	—
Indi-X Indicators	—	—	—	✓



54-530-335-0

### Mark VI Electronic Indicators

Our **BEST** electronic indicators!



#### Features:

- IP54 protected against fluid and dust
- Output: Proximity/Power - USB/RS232/digimatic/Wireless
- Functions (MIN/MAX/DELTA, TOL, Factor, Preset, Auto Off)
- Large display with LED tolerance indicators



**sylvac**

**SWISS PRECISION**



Calibration certificates available for all sizes.

Order No.	Range	Accuracy	Resolution	List Price	Sale Price
Low Resolution					
54-530-125-0	0 - 0.500"/12.5mm	0.0004"/0.01mm	0.0005"/0.01mm	\$576.32	<b>\$519.00</b>
54-530-145-0	0 - 1"/25mm	0.0004"/0.01mm	0.0005"/0.01mm	\$657.81	<b>\$593.00</b>
High Resolution					
54-530-135-0	0 - 0.500"/12.5mm	0.00012"/0.003mm	0.00005"/0.001mm	\$713.10	<b>\$642.00</b>
54-530-155-0	0 - 1"/25mm	0.00016"/0.004mm	0.00005"/0.001mm	\$681.61	<b>\$614.00</b>
54-530-175-0	0 - 2"/50mm	0.00019"/0.005mm	0.00005"/0.001mm	\$1,368.02	<b>\$1,232.00</b>
Bluetooth					
54-530-335-0	0 - 0.500"/12.5mm	0.00012"/0.003mm	0.00005"/0.001mm	\$902.31	<b>\$813.00</b>
54-530-355-0	0 - 1"/25mm	0.00016"/0.004mm	0.00005"/0.001mm	\$841.83	<b>\$758.00</b>
Accessories					
54-981-713-2	Sylcom Basic Data Processing Software			\$810.58	<b>\$771.00</b>
54-981-724-5	Sylcom Pro Digital License			\$1,939.95	<b>\$1,843.00</b>
54-115-246-BT	USB Bluetooth Receiver			\$49.45	<b>\$43.00</b>



54-520-285-0

### INDI-X<sup>®</sup> BT Electronic Indicators

Smart Wireless Communication to most phones and tablets



#### Features:

- Bluetooth compatible to most phones and tablets
- Resolution 0.00005"/0.001mm
- Economical bluetooth option
- Includes lifting hook, ceramic ball contact point, 2 specialty contact points (spline and point), NIST cert., lug and flat backs

54-520-280-0

Calibration certificates available for all sizes.

Order No.	Range	Accuracy	List Price	Sale Price
54-520-280-0	0 - 1"/25mm	0.00035"/0.008mm	\$193.23	<b>\$165.00</b>
54-520-285-0	0 - 0.50"/12.5mm	0.00030"/0.007mm	\$186.86	<b>\$159.00</b>

Our most popular electronic indicators.



54-520-255-0

54-520-250-0

54-520-260-0

**Features:**

- Accuracy:  $\pm 0.001''/0.03\text{mm}$
- Resolution  $0.0005''/0.01\text{mm}$
- 54-520-260-0 also reads 1/64ths
- 2-1/4" dial face
- Lugback and 3/8" stem mountings
- Tolerance function
- Absolute/incremental reading
- Floating zero

Calibration certificates available for all sizes.

Order No.	Range	List Price	Sale Price
54-520-255-0	0.50"/12.5mm	\$117.76	<b>\$95.00</b>
54-520-250-0	1"/25mm	\$133.36	<b>\$107.00</b>
54-520-260-0	1"/25mm	\$135.38	<b>\$109.00</b>

## Mini S\_Dial Indicators

Small in size BIG in features!

**Features:**

- Bluetooth connectivity to your phone or tablet
- IP67 protected against fluid and dust
- All indicators feature 0.50"/12.5mm range
- Analog scale for reversal point indication, Min/Max, multiplication factor (Bluetooth® models only)
- 3/8" mounting diameter with 4-48 contact thread
- Auto power off feature
- Optional cable connectivity output



54-520-687-BT

54-520-692-0



Calibration certificates available for all sizes.

Order No.	Accuracy	Resolution	List Price	Sale Price
<b>Bluetooth Models</b>				
54-520-687-BT	0.0004"/0.01mm	0.0005"/0.01mm	\$592.58	<b>\$534.00</b>
54-520-690-BT	0.0002"/0.005mm	0.00005"/0.001mm	\$860.27	<b>\$775.00</b>
<b>Basic Models (Zero set, preset, in/mm, measuring direction)</b>				
54-520-691-0*	0.0004"/0.01mm	0.0005"/0.01mm	\$498.06	<b>\$449.00</b>
54-520-692-0*	0.0002"/0.005mm	0.00005"/0.001mm	\$687.64	<b>\$619.00</b>
<b>Accessories</b>				
54-981-713-2	Sylcom Basic Data Processing Software		\$810.68	<b>\$771.00</b>
54-115-528-0	USB Power Cable		\$323.33	<b>\$292.00</b>

\*Bluetooth models feature zero, data, preset, direction, min/max/delta, resolution, multiplication factor

## Premium Dial Indicators

Smooth, accurate and built tough.

### Features:

- AGD Group 2 specifications
- Shockproof gearing
- Jeweled movement
- Tolerance markers
- Solid steel housing
- Carbide contact point
- Includes NIST Certification



52-520-135-0



52-520-105-0



52-520-110-1



Order No.	Range	Graduation	Reading	Balanced Reading	Dial Color	List Price	Sale Price
52-520-135-0	0.05"	0.0001"	0 - 10	0 - 5 - 0	White	\$205.54	<b>\$155.00</b>
52-520-105-0	0.50"	0.001"	0 - 100	0 - 50 - 0	White	\$95.08	<b>\$72.00</b>
52-520-110-1	1"	0.001"	0 - 100	—	Black	\$100.53	<b>\$76.00</b>
52-520-110-2	1"	0.001"	0 - 100	—	White	\$100.53	<b>\$76.00</b>
52-520-120-0	2"	0.001"	0 - 100	—	White	\$160.27	<b>\$121.00</b>
52-520-125-0	0.250"	0.0005"	0 - 100	—	White	\$132.65	<b>\$100.00</b>
52-520-129-0	1"	0.0005"	0 - 50	0 - 25 - 0	White	\$121.52	<b>\$92.00</b>
52-520-300-0	10mm	0.01mm	0 - 100	0 - 50 - 0	White	\$114.79	<b>\$87.00</b>
52-520-500-0	25mm	0.01mm	0 - 100	0 - 50 - 0	White	\$153.00	<b>\$115.00</b>

## Premium IP54 Shockproof Dial Indicators

### Features:

- IP54 protected against fluid and dust
- Includes both center lug back and flat back
- Steel housing
- Sealed plunger, dust-cap and back plate
- Carbide contact point
- 0 - 100 dial reading with revolution counter
- Includes NIST Certification



52-520-460-0



52-520-465-0

Order No.	Range	Graduation	Reading	Contact Point	List Price	Sale Price
52-520-460-0	1"	0.001"	0 - 100	4 - 48 (3/8" stem)	\$96.98	<b>\$78.00</b>
52-520-465-0	1"	0.001"	0 - 100	4 - 48 (3/8" stem)	\$96.98	<b>\$78.00</b>

## Depth Base Attachments

Turn your indicator into a depth gage, instantly.

### Features:

- Turn your dial or electronic indicator into a depth gage
- 4" length for accuracy
- Fits indicators with 3/8" and 8mm mounting stems
- Ground and lapped base
- Each supplied with 4 extension points, for added application range (4 - 48 thread)
- 52-125-005-0 has 0.430" radius



52-125-004-0

Order No.	Description	List Price	Sale Price
52-125-004-0	Flat depth base attachment	\$44.22	<b>\$31.00</b>
52-125-005-0	Radius style depth base attachment	\$50.61	<b>\$36.00</b>





# Electronic Test Indicators

### Features:

- Bluetooth connectivity to your phone or tablet
- IP65 protected against fluid and dust
- 4 measuring modes: Min, Max, TIR and Direct
- 4 measuring resolutions - 0.00005"/0.001mm or 0.0005"/0.01mm
- 1-1/2" diameter dial face rotates a full 360°
- Analog scale for reversal point indication
- Meets or exceeds DIN/ISO Standards  
(Maximum error on 0.00005" scale at full range: 0.0004")
- 54-562-890-BT is capable of interchanging contact point lengths



54-562-777-BT



Calibration certificates available for all sizes.

Order No.	Range	Contact Point Length	List Price	Sale Price
54-562-777-BT	0.030"/0.80mm	1/2"	\$582.41	<b>\$486.00</b>
54-562-888-BT	0.080"/2.0mm	1-7/16"	\$658.71	<b>\$560.00</b>
54-562-890-BT	0.030"/0.80mm 0.080"/2.0mm	1/2" 1-7/16"	\$820.82	<b>\$698.00</b>
Accessories				
54-981-713-2	Sylcom Basic Data Processing Software		\$810.68	<b>\$771.00</b>
54-115-528-0	USB Power Cable		\$323.33	<b>\$292.00</b>

# X-TEST®

## Horizontal & Vertical Test Indicators

### Features:

- Super smooth jeweled movement
- Smooth bezel adjustment for easy zero setting
- Solid brass anti-magnetic housing
- 0.080" and 0.120" carbide ball contact points (0.040" steel ball)
- 0.060" range with auto reverse and rev. counter
- Easy to read tilted dial
- 5/32" pivotable stem



52-562-005-0



52-562-001-0



52-562-002-BD

Order No.	Graduation	Dial Size	Dial Reading	List Price	Sale Price
Horizontal					
52-562-001-0	0.0005"	1-1/2"	0 - 15 - 0	\$143.15	<b>\$122.00</b>
52-562-001-BD	0.0005"	1-1/2"	0 - 15 - 0	\$143.15	<b>\$122.00</b>
52-562-002-0	0.0005"	1"	0 - 15 - 0	\$143.15	<b>\$122.00</b>
52-562-002-BD	0.0005"	1-1/2"	0 - 15 - 0	\$143.15	<b>\$122.00</b>
52-562-003-0	0.001"	1"	0 - 15 - 0	\$163.82	<b>\$140.00</b>
52-562-008-0	0.01mm	38mm	0 - 40 - 0	\$164.19	<b>\$140.00</b>
Vertical					
52-562-004-0	0.0005"	1-1/2"	0 - 15 - 0	\$156.74	<b>\$118.00</b>
52-562-005-0	0.0005"	1"	0 - 15 - 0	\$179.38	<b>\$135.00</b>

Prices & Specifications are subject to change without notice.



## S Depth Gages

Perfect for measuring depths, groove widths, slot widths, recess heights, step heights and through holes.

### Features:

- IP67 protected against fluid and dust
- Bluetooth connectivity to your phone or tablet
- 3 measuring styles available
- 4"/100mm measuring base as standard
- Optional probes available for 54-139-160 series
- Extra large display
- Absolute measuring system



Rotary Pin Series  
54-139-162-3



54-139-161-1



54-139-160-5



Contact our Technical Department for optional bases and contacts.

Order No.	Description	List Price	Sale Price
54-139-160-1	8"/200mm Interchangeable Anvil Bluetooth Depth Gage	\$1,349.30	<b>\$1,215.00</b>
54-139-160-3	12"/300mm Interchangeable Anvil Bluetooth Depth Gage	\$1,555.30	<b>\$1,400.00</b>
54-139-160-5	19"/500mm Interchangeable Anvil Bluetooth Depth Gage	\$2,080.60	<b>\$1,873.00</b>
54-139-161-1	8"/200mm Standard Style Bluetooth Depth Gage	\$1,277.20	<b>\$1,150.00</b>
54-139-161-3	12"/300mm Standard Style Bluetooth Depth Gage	\$1,410.00	<b>\$1,269.00</b>
54-139-161-5	19"/500mm Standard Style Bluetooth Depth Gage	\$1,833.40	<b>\$1,651.00</b>
54-139-162-1	8"/200mm Rotary Pin Bluetooth Depth Gage	\$1,380.20	<b>\$1,243.00</b>
54-139-162-3	12"/300mm Rotary Pin Bluetooth Depth Gage	\$1,555.30	<b>\$1,400.00</b>
54-139-162-5	19"/500mm Rotary Pin Bluetooth Depth Gage	\$2,111.50	<b>\$1,901.00</b>

## X-DEPTH 22<sup>®</sup> 0 - 22" Dial Depth Gage



### Features:

- 0 - 1" travel indicator with 4" base
- 0.001" Graduations
- Rods connect together for full 22" capacity
- Satin chrome finish
- Includes 2 extra points for small hole applications; one 0.078" dia. x 1" long and one needle point x 1" long

Order No. 52-125-006-1

**Sale \$169.<sup>00</sup>**

List Price \$224.29

## X-PROOF<sup>®</sup> 0 - 22" Dial Depth Gage

with IP54 protection!



### Features:

- 0 - 1" travel indicator with 4" base
- Sealed bezel, top cap and dial with bellows on stem
- 0.001" graduations
- Rods connect for 22" capacity
- Includes 2 extra points (spline & needle)

Order No. 52-125-007-0

**Sale \$109.<sup>00</sup>**

List Price \$216.64

# Granite Dial Gage Stand

*Sturdy with 0.00005" flatness*

## Features:

- 6" x 6" x 2" granite base
- Positive lock screw
- Fine adjustment knob for zero setting
- Column height is 8"
- Accepts all lug-back indicators
- This stand is maintenance free



Order No. 52-580-030-0

**Sale \$108.00**

List Price \$133.84

# Magnetic Base

## Features:

- 9.5" Height and 85 lb. pull
- Base dimensions are 2" x 2-11/32" x 1-13/16"
- Accepts all AGD dial indicators
- V-bottom base allows mounting on cylindrical surfaces
- Mounts test indicators with 1/4" post mount



Order No. 52-585-005-0

**Sale \$50.00**

List Price \$66.07

# Hydraulic Arm Magnetic Base

*Heavy duty holding power*

## Features:

- Adjusts to virtually any position
- All purpose magnetic base with 180 lbs. of pulling power
- Fine adjustment
- Base can be mounted vertically as well as horizontally,
- V-bottom base allows mounting on cylindrical surfaces



Order No. 52-585-095-0

**Sale \$201.00**

List Price \$267.42

*Prices & Specifications are subject to change without notice.*

## Clinotronic-S

The Clinotronic-S is a portable precision instrument for measuring inclinations up to  $\pm 45^\circ$ .

The large, backlit, high contrast color display provides excellent readability even under adverse conditions in the workshop or under a machine.

The Clinotronic-S can be connected to an Android™ device, which can then be used as a remote display. This new feature makes the instrument much more versatile and suitable for many applications. It is built on the success of the Clinotronic PLUS, while retaining the features that made it famous, like its reliability and versatility, plus it adds the latest technology:



### Features:

- Wireless functionality (APP wylerUNIVERSAL for Android™)
- Data transmission via USB cable as well
- User friendly
- Adjustable to local gravity
- Improved mechanical accuracy
- Excellent color display with low power consumption



Order No. 54-635-605-0

**Sale \$3,762.00**

List \$4,180.00

## Clinotronic Plus

The Fowler Wyler Clinotronic Plus is an electronic level with unsurpassed versatility. It is economically priced, uses a specially designed microprocessor and the well-proven Wyler inclination sensor.



### Features:

- Range of  $\pm 45^\circ$ , capacity of 0-360°
- Resolution of 0.01° (selectable)
- Absolute or relative measuring mode selectable by push button
- Seal-tec technology for excellent performance even in difficult environmental conditions
- Interface connection RS-232 is integrated. Special purpose cables available
- No loss of calibration data by power failure
- Response time: value available within 5 seconds
- Repeatability:  $<.01^\circ$
- Linearity: 3 min. of arc + 1
- Housing: aluminum hard anodized.
- Dimensions: 4 x 3 x 1" (100 x 75 x 30mm)



Order No. 54-635-601-0

**Sale \$2,248.00**

List \$2,496.69

## mini-MAG Protractor

The mini-MAG Protractor provides instant 360° digital inclination display of any angle.

**Features:**

- Accuracy: ± 0.2°
- Resolution: 0.05°
- Embedded magnets
- Display automatically inverts
- Dimensions: 2.375" x 1.375" x 2.375"
- Hold feature
- Battery Life: up to 250 hrs.



Display inverts for easy reading!



Order No. 54-422-450-1

**Sale \$92.00**

List Price \$108.04

## mini-MAG II

The mini-MAG II Protractor provides instant 360° digital inclination display of any angle.

**Features:**

- On/off, tilt %, light, zero functions
- Display is backlit for low light areas
- Embedded magnets with 3.5lb. pull
- Display automatically inverts
- Measuring range: 360° (4 x 90°)
- Accuracy: ± 0.2°
- Resolution: 0.05°
- Dimensions: 2.375" x 1.375" x 2.375"
- Hold feature



Order No. 54-422-460-0

**Sale \$107.00**

List \$133.60

## mini-MAG PLUS

The Mini-Mag PLUS Protractor features a USB rechargeable battery, a backlit display, Tilt% function.

**Features:**

- IP54 protected against fluid and dust
- Auto off after 5 minutes
- Embedded magnets
- Display automatically inverts
- Smaller size: 2.12" x 2.12" x .9"
- Measuring range: 360° (4 x 90)
- Accuracy: ± 0.2°
- Resolution: 0.05°
- Hold feature



Order No. 54-422-500-0

**Sale \$117.00**

List \$146.12

## Digi Level PLUS+

with smart wireless data

**Features:**

- IP65 protected against fluid and dust
- Large auto inverting display
- Includes a 6" straight edge with beveled edge and 1/32nds graduations
- Smart wireless available to connect to phone or tablet
- V's on top and bottom for measuring on cylindrical surfaces
- Embedded magnets on bottom base for vertical and horizontal hold
- Accuracy: ± 0.2°
- Resolution: 0.050°



Order No. 54-422-550-BT

**Sale \$151.00**

List Price \$177.30

## Rules

### EZ-Read Black Face Rules

- Hardened stainless steel
- White easy-to-read microfine graduations against a black, non-glare finish

### Satin Chrome Rules

- Tempered steel
- Non-glare
- Sharp, easy-to-read microfine graduations

### Rigid Steel Rules

Order No.	Finish	Size	Reading	List Price	Sale Price
52-330-006-0	Satin Chrome	6"	4R	\$15.57	<b>\$14.00</b>
52-337-006-0	Black	6"	4R	\$12.39	<b>\$11.00</b>
52-330-012-0	Satin Chrome	12"	4R	\$26.59	<b>\$24.00</b>
52-337-012-0	Black	12"	4R	\$23.84	<b>\$22.00</b>
52-350-006-0	Satin Chrome	6"	16R	\$14.34	<b>\$13.00</b>
52-338-006-0	Black	6"	16R	\$15.84	<b>\$14.00</b>
52-350-012-0	Satin Chrome	12"	16R	\$31.07	<b>\$28.00</b>

### Flexible Steel Rules

Order No.	Finish	Size	Reading	List Price	Sale Price
52-295-006-0	Satin Chrome	6"	4R	\$12.93	<b>\$12.00</b>
52-297-006-0	Black	6"	4R	\$12.76	<b>\$11.00</b>
52-295-012-0	Satin Chrome	12"	4R	\$26.84	<b>\$25.00</b>
52-297-012-0	Black	12"	4R	\$18.74	<b>\$17.00</b>
52-308-006-0	Black	6"	16R	\$12.41	<b>\$11.00</b>
52-310-006-0	Satin Chrome	6"	16R	\$13.35	<b>\$12.00</b>
52-308-012-0	Black	12"	16R	\$18.74	<b>\$17.00</b>

## 6"/150mm Pocket Steel Rule

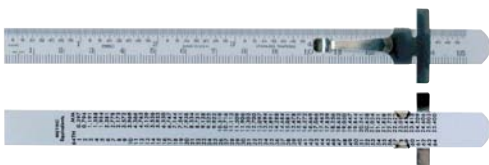

- Rounded edge prevents damage to shirt pocket
- Inch graduations are in 64ths
- Metric scale is in 1mm increments
- Rule width: 0.470"
- Rule thickness: 0.021"

Order No. 52-380-100-0

**Sale \$8.00**

List Price \$9.28

## Carbide Super Scriber



- Lightweight
- Retractable carbide tip
- Knurled grip
- Machined aluminum body
- Pocket clip

Order No.	Description	Overall Length	List Price	Sale Price
52-500-050-0	Carbide Super Scriber	6.5"	\$37.00	<b>\$34.00</b>
52-500-055-0	Carbide Refill		\$11.75	<b>\$11.00</b>

52-297-006-0



52-330-006-0



### GRADUATIONS

**4R:** 8ths, 16ths, 32nds, 64ths  
**16R:** 32nds, 64ths, 50ths, 100ths

## Combination Squares



### Features:

- Blades are chrome plated, fully hardened and tempered
- 4 piece includes: square, protractor and center heads with 12" blade
- 2 piece includes: square head and 12" blade
- Square head has level and scriber point
- Double indexed protractor is graduated 180° in both directions
- Graduated in 8ths, 16ths, 32nds and 64ths

Order No.	Description	List Price	Sale Price
52-370-012-0	4 pc.	\$263.45	<b>\$198.00</b>
52-373-012-0	2 pc.	\$169.55	<b>\$136.00</b>

## Cylindrical Squares



### Features:

- Used for checking squares, height gages and other instruments
- Hardened and the ends are lapped to 90° angular accuracy
- 6" cylindrical squares: ± 0.0001"
- 12" cylindrical square: ± 0.00015"

Order No.	Description	List Price	Sale Price
52-750-006-0	6"	\$256.44	<b>\$231.00</b>
52-750-012-0	12"	\$366.22	<b>\$330.00</b>

## Steel Squares and Sets

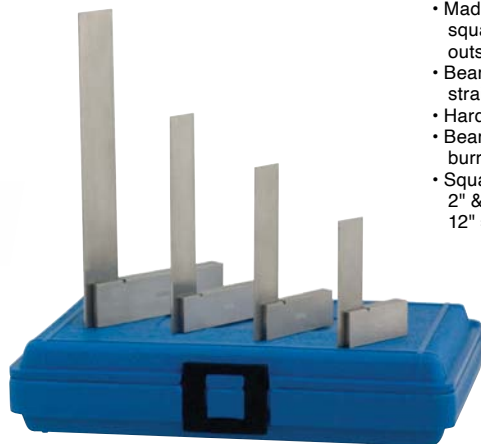

### Features:

- Made of carbon tool steel, these economy squares have true right angles both inside and outside
- Beams and blades ground and lapped for straightness and parallelism
- Hardened blade
- Beam grooved at inner corner for clearance of burrs and dirt
- Squareness of blade edge to the working face: 2" & 3" = ± 0.0006", 4" & 6" = ± 0.0008", 9" & 12" = ± 0.0012"

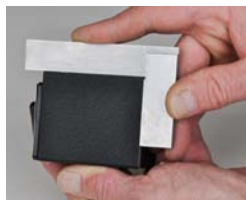

Order No.	Description/Size	List Price	Sale Price
52-432-006-0	6" Square ONLY	\$33.35	<b>\$31.00</b>
52-432-009-0	9" Square ONLY	\$67.11	<b>\$61.00</b>
Sets			
52-432-246-0	4 piece Square Set, 2", 3", 4" & 6"	\$105.87	<b>\$96.00</b>
52-432-469-0	4 piece Square Set, 4", 6", 9" & 12"	\$182.18	<b>\$164.00</b>

## X-BLOX® V-Block Set

### 2 each @:

- Dimensions: 1-1/2" L x 1-1/4" W x 1-1/4" H
- Work capacity: Approximately 1"

### 2 each @:

- Dimensions: 2" L x 1-1/2" W x 1-1/2" H
- Work capacity: 1-1/2"

### All feature:

- Surfaces are square and parallel within 0.0005"
- V-grooves are square and parallel with all surfaces within 0.0005"
- Corresponding dimensions for each pair are alike within 0.0005"



Order No. 52-475-500-0

**Sale \$131.00**

List Price \$144.97

## V-Block Set



### Features:

- Hardened steel. All sides of V-Blocks precision ground parallel and square within 0.0004"
- Height: 2", Length: 2-3/4", Width: 2"
- Two clamps, with screw hole at 90 degrees for positive clamping of work, are included
- Clamping capacity= 2"/50m
- V-Blocks are constructed with stepped grooves which allow the clamps to be inserted without protrusion, thus allowing V-Blocks to be used on base, ends or sides
- Matched pair of V-Blocks are perfectly aligned with 90 degree V-grooves ground central and parallel to the sides and bases

Order No. 52-475-555-0

**Sale \$254.00**

List Price \$317.46

## Toolmaker's Vise

*Toolmaker's Vise makes precision holding possible for inspection, precision jig boring, milling and grinding*



### Features:

- Maximum opening: 2.48"
- Dimensions: 6.1" x 1.9" x 2.0"
- Features solid base and front jaw construction
- Parallelism and squareness accuracy: 0.0004"
- Clamping slots on the bottom of the base allow for easily affixing to angle plates, vises, etc.

Order No. 52-466-000-1

**Sale \$197.00**

List Price \$245.07



# 1-2-3 & 2-4-6 Blocks

Useful in layout, inspection and grinding work

### Features:

- 23 holes for easy clamping
- Sold in pairs
- Hardened 56 - 60 HRC
- Both styles include 5 threaded holes, 3/8" - 16



52-439-246-0

Order No.	Description	Accuracy	List Price	Sale Price
52-439-031-0	1-2-3 Blocks	± 0.0001"/1"	\$46.34	<b>\$38.00</b>
52-439-032-0	1-2-3 Blocks	± 0.0002"/1"	\$96.47	<b>\$87.00</b>
52-439-246-0	2-4-6 Blocks	± 0.0003"/1"	\$176.39	<b>\$142.00</b>

# Parallel Sets

2 thicknesses to choose from!

### Features:

- 2 each of 1/2", 5/8", 3/4", 7/8", 1", 1-1/8", 1-1/4", 1-3/8", 1-1/2" & 1-5/8" heights
- Absolute heights are nominal
- Hardness: 50 HRC, 6" length
- 52-437-000-0 paired in height: 0.0001"
- 52-437-000-0 paired in height: 0.001"



52-437-031-0



52-437-000-0

Order No.	Description	Parallelism	List Price	Sale Price
52-437-000-0	1/32" Parallel Set	± 0.0008"	\$270.98	<b>\$231.00</b>
52-437-031-0	1/8" Parallel Set	± 0.0001"	\$291.81	<b>\$249.00</b>

# Angle Blocks



### Features:

- Each 12 block set includes 1 thru 5° blocks in 1° increments and 5° through 30° blocks in 5° increments as well as 1/4° & 1/2° blocks
- Accuracy: ± 2.5 arc minutes
- Use of the Solid Angle Block simplifies the setting and checking of angles during tooling, production or inspection. This fast, accurate method eliminates time consuming calculations, sine bar and any setup errors.
- All blocks precision ground
- All blocks are 3" long and 1/4" thick

Order No. 52-475-500-0

**Sale \$133.00**

List Price \$165.60

Prices & Specifications are subject to change without notice.

# COAX-2D 2 Dimensional Coaxial Indicator Sets

Use the 2D Coaxial Set for accurate component centering and positioning in most machining applications. The dial remains stationary during the rotation of the machine spindle.

## Features:

- Graduations and revolution counter 0.0005"/0.01mm
- 3 internal and 3 external feelers; ball dia.: 1/8" (3mm)
- Includes center point feeler and staining arm
- Restraining arm
- Shank: 3/8" dia. x 7/8" long (10mm x 20mm)
- Measuring range: 0.250" (6mm) axis offset
- Speed recommended 800 RPM max.
- Repeatability to within 0.0002" (0.005mm) of true center
- Capacity, depending on feeler is 5/32-12"/4-300mm internal diameter; 0-12"/0-300mm external diameter



52-710-025-0

Order No.	Description	List Price	Sale Price
52-710-025-0	2D Coaxial Set - Inch	\$289.55	<del>\$232.00</del>
52-710-030-0	2D Coaxial Set - Metric	\$279.67	<del>\$238.00</del>

## Electronic Edge Finders



### Features:

- Six equally spaced light ports provide visibility at any angle
- Edge finder lights instantly when stylus touches work edge
- Repeatability: 0.0002"
- Works on any conductive metal



Along with light indication, model #54-575-650-0 emits an audible "beep" at time of contact

Order No.	Stylus	Shank	Audible	List Price	Sale Price
54-575-600-0	0.200"	1/2"	NO	\$45.42	<del>\$41.00</del>
54-575-625-0	0.200"	1/2"	NO	\$141.14	<del>\$128.00</del>
54-575-650-0	0.400"	3/4"	YES	\$163.09	<del>\$147.00</del>



## Quill Kit

Digital display for drill presses and milling machines

### Features:

- IP54 protected against fluid and dust
- Includes quill installation tool kit
- Range: 0 - 6"/150mm
- Accuracy:  $\pm 0.001"/0.03$ mm
- Resolution: 0.0005"/0.01mm/1/64"
- Preset, zero, in/mm, absolute/incremental, on/off functions
- Stainless steel construction
- Interchangeable mounting brackets with hardware



Order No. 54-050-100-0

**Sale \$162.00**

List Price \$189.80

# Z-CHECK 65 PLUS+

## Z-Axis Tool Setter

TOOL-A-THON  
**BEST SELLER!**  
FOWLER HIGH PRECISION

### Features:

- Supplied with zero reference setting block
- IP65 protected against fluid and dust
- Back light turns on when zero reference is achieved
- 4 magnets embedded into base
- 2" default setting height
- Steel contact surface with 0.0002" flatness
- Resolution: 0.00005"/0.001mm
- Repeatability: 0.00015"/0.004mm
- Accuracy: 0.0001"/0.003mm
- Includes a rugged, aluminum fitted case



Protected to:  
**IP65**  
DUST & FLUID  
RESISTANT

Order No. 54-188-200-0

**Sale \$113.00**

List Price \$125.06

## HIGH Accuracy Z-Axis Detectors



For use in CNC machines and other applications where high accuracy is required!



54-188-140-0



Protected to:  
**IP67**  
DUST & FLUID  
RESISTANT

### Features:

- IP67 protected against fluid and dust
- High accuracy and repeatability,  $\pm 0.000039"/0.001$ mm
- Carbide touch surface (0.196"/5mm)
- High precision bearing guide system for long life
- Interchangeable magnetic base
- High visibility LED indicator
- Movement stroke 0.078"/2mm
- Battery life approximately 250 hours (on time)

54-188-140-0

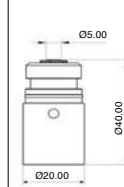

54-188-150-0

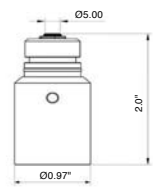

Order No.	Model	Dimensions	List Price	Sale Price
54-188-150-0	Inch	Height: 2"/50.8mm, Dia. 0.97"/24.638mm	\$268.62	<b>\$242.00</b>
54-188-140-0	Metric	Height: 1.57"/40mm, Dia. 0.78"/20mm	\$307.42	<b>\$277.00</b>

Prices & Specifications are subject to change without notice.

# QUICK CHECK

## Multi-Function Check Standard



### Check

- ✓ Height Gages
- ✓ Micrometers
- ✓ Depth Gages
- ✓ Bore Gages
- ✓ Test & Dial Indicators
- ✓ Caliper Gages
- ✓ Protractors & more ....

#### Features:

- All sizes marked are actual
- Accuracy of indicated values  $\pm 0.00012''$
- One compact, multi-function, precise standard
- Can be used to check and verify a multitude of measuring instruments
- Supplied with a manufacturer's test certificate and fitted wood case

Order No. 53-813-015-0

# Sale \$1,553.<sup>00</sup>

List Price \$1,826.99

## SHOP-BLOX<sup>®</sup>

### Rectangular Gage Block Sets



53-672-081-0

#### Features:

- Manufactured to meet Federal Specification ASME B89. 1.9 - 2002 tolerances on length for inch gage blocks
- Certificate of Calibration traceable to NIST
- Tolerances to  $\pm 0.00005''$
- In high-quality fitted wood case

Order No.	Description	List Price	Sale Price
53-672-036-0	36 pc.	\$358.62	<b>\$269.00</b>
53-672-081-0	81 pc.	\$613.39	<b>\$461.00</b>

## Grade 0 Rectangular Steel Gage Block Set



53-670-038-0

#### Features:

- Grade 0
- Certificate of Calibration traceable to N.I.S.T.
- Each block is individually serialized
- Sizes clearly marked on each block
- Complete with fitted wooden case

Order No.	Description	List Price	Sale Price
53-670-038-0	36 pc.	\$529.13	<b>\$450.00</b>
53-670-080-0	81 pc.	\$973.68	<b>\$828.00</b>

# Tool Set 300 Presetter

Used for the quick checking of heights and diameters (radii) of various types of machine tools. Accuracy is guaranteed by a precise steel measuring column and displacement devices in X and Z coordinates utilizing constant measuring force.

## Tool Holding Spindle

- Tool presetter is supplied with high precision tool pot (Grade 0)
- ISO 50 taper
  - Less than 0.00008"/0.002mm concentricity error

## Features:

- Measuring range: (X)11.8"/300mm, (Z)15.7"/400mm
- Min/Max functions for TIR readings
- 2 reference indications
- Preset and Tolerance value inputs
- Radius or diameter indication on X-axis display
- Resolution: 0.00005"/0.001mm
- Floating zero function anywhere within axis range
- Carbide measuring insert for durability
- Counter balanced measuring carriage
- Constant measuring force in both axes
- **High precision Swiss measuring system**



Order No.	Description	List Price	Sale Price
54-188-300-0	Tool Presetter	\$10,800.86	<b>\$9,721.00</b>
54-121-005-0	ISO 50/40 Tool Pot Adapter	\$751.82	<b>\$715.00</b>

# Weight & Counting Scale



## Features:

- Accurately measures weights and quantities
- Use for counting large batches of small parts
- Measure weights up to 66 lbs./30 kg.
- Removable stainless steel weighing pan and durable ABS housing
- Converts pounds, ounces, grams, kilograms
- Internal battery with 100 hours of use
- Front panel leveling indicator with adjustable leveling feet
- 3 panel backlit LCD display indicates weight, average piece weight and count

**Measures up to 66 lbs.!**

Order No. 54-750-030-0

**Sale \$149.00**



List Price \$174.67



# X-PRO™

## Portable Roughness Tester II

Quick, easy roughness testing



(X-Pro shown with optional stand with swivel)

The X-Pro Portable Roughness Tester II can be used for various applications by selecting from a variety of accessories including special application probes and a swivel stand.

RS232 data output is available on additional models (contact the Fowler technical department for more information 1-800-788-2353)

### Features:

- Small, compact size
- 2 selectable parameters: Ra and Rz
- Large LCD display
- Meets ISO and DIN standards
- NIST traceable specimen included
- Uses 9 volt battery (approx. 3000 measurements)
- Includes fitted case

### X-Pro Portable Roughness Tester II

Order No.	Description	List Price	Sale Price
54-410-500-0	Portable Surface Roughness Tester 0.0004" probe (NIST specifications)	\$2,039.35	<b>\$1,836.00</b>
54-410-600-0	Portable Surface Roughness Tester 0.0002" probe (DIN specifications)	\$2,039.35	<b>\$1,836.00</b>

### X-Pro Portable Roughness Tester II Stand with Swivel

Order No.	Description	List Price	Sale Price
54-400-896-0	Stand with Swivel Attachment	\$491.18	<b>\$443.00</b>

### X-Pro Portable Roughness Tester II Probes and Accessories

Order No.	Description	Resolution	List Price	Sale Price
54-400-319-0	General Purpose Probe	0.0004"	\$845.42	<b>\$761.00</b>
54-400-326-0	General Purpose Probe	0.0002"	\$916.62	<b>\$825.00</b>
54-420-321-0	Small Bore Probe	0.0004"	\$886.75	<b>\$799.00</b>
54-420-327-0	Small Bore Probe	0.0002"	\$1,014.84	<b>\$914.00</b>
54-420-301-0	Traverse Chisel Probe	0.0004"	\$886.75	<b>\$799.00</b>
54-420-302-0	Parallel Chisel Probe	0.0004"	\$886.75	<b>\$799.00</b>
54-420-328-0	Groove Bottom Probe	0.0004"	\$936.02	<b>\$843.00</b>

# ISO 17025, A2LA Accredited Calibration Lab Service and Repair and Calibration

At Fowler, we proudly provide precise and accredited calibration services for various equipment. As an ISO 17025 and A2LA certified lab, we uphold rigorous industry standards to ensure quality and traceability in our calibration processes. Count on our advanced facilities and skilled, factory-trained technicians for exceptional calibration services.

## Accreditations and Certifications:

### ISO 17025

Our calibration lab is ISO 17025 accredited, demonstrating our competence in producing reliable calibration results. This internationally recognized accreditation assures our customers that we follow stringent quality management practices, technical expertise, and continuous improvement.



### A2LA

As an A2LA accredited calibration lab, we have undergone a rigorous evaluation process to validate our adherence to the highest technical and management requirements. This accreditation further strengthens our commitment to accuracy, precision, and customer satisfaction.



Ring Certification



Height Gage Certification



Gage Block Certification

## Service Card

### Dimensional

Bore Gages  
Calipers  
CMMs/Arms  
Depth Gages  
Displays and Probes  
Feeler Gages  
Height Gages  
Universal Length Machines (ULMs)  
ID/OD Gages  
Indicators  
Micrometers  
Micrometer Heads  
Rules  
Thickness Gages

### Optical

Optical Comparators  
Optical Scanning Systems  
Vision and Multi-Sensor System  
Rapid Scan Field of View System

### Fixed Gages

Gage Blocks  
Micrometer Standards  
Pin Gages  
Ring Gages

**Contact Us Today:** To learn more about our ISO 17025, A2LA accredited calibration lab and discuss your specific calibration needs, please reach out to our dedicated team:



### East Coast Lab

780 Dedham Street • Canton, MA 02021  
Tel: (800) 788-2353  
Email: calvin@fowlerprecision.com



### West Coast Lab

28010 Industry Drive • Valencia, CA 91355  
Tel: (661) 295-1237  
Email: jamel@fowlerprecision.com



**Headquarters**

780 Dedham Street • Canton • Massachusetts 02021  
(800) 788-2353 • (617) 332-4137 fax  
sales@fowlerprecision.com • www.fowlerprecision.com

**Distribution Center & Showroom**

28010 Industry Drive  
Valencia, California 91355  
(415) 633-5354

*Find us on social media*

